

Ventilation Detail Code 111 (A 1-14)

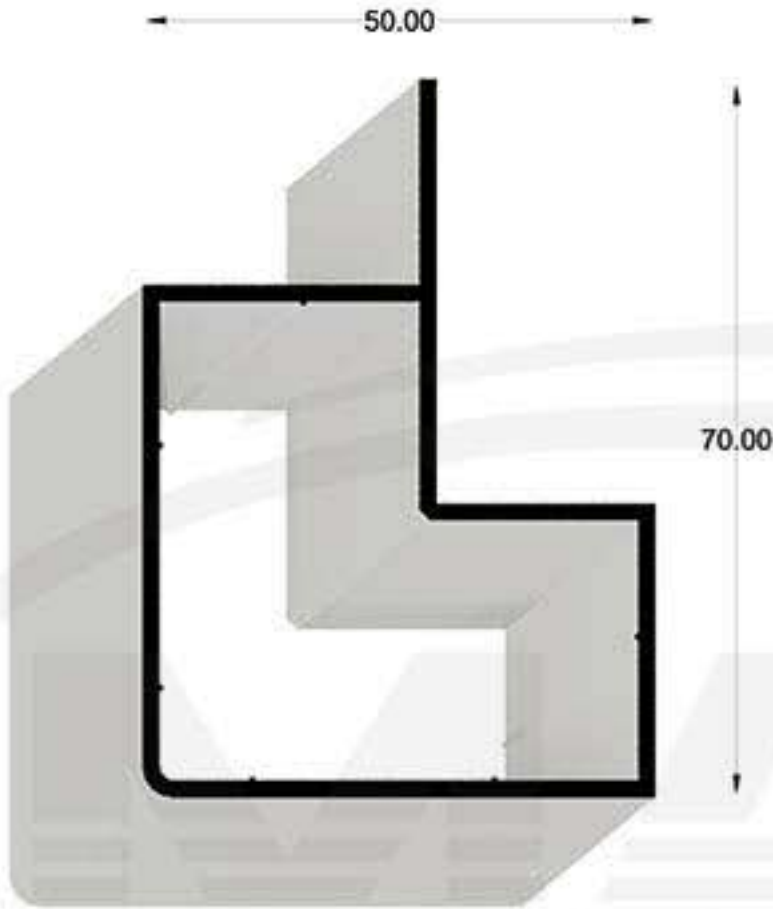

111A-1
1500 gr/m

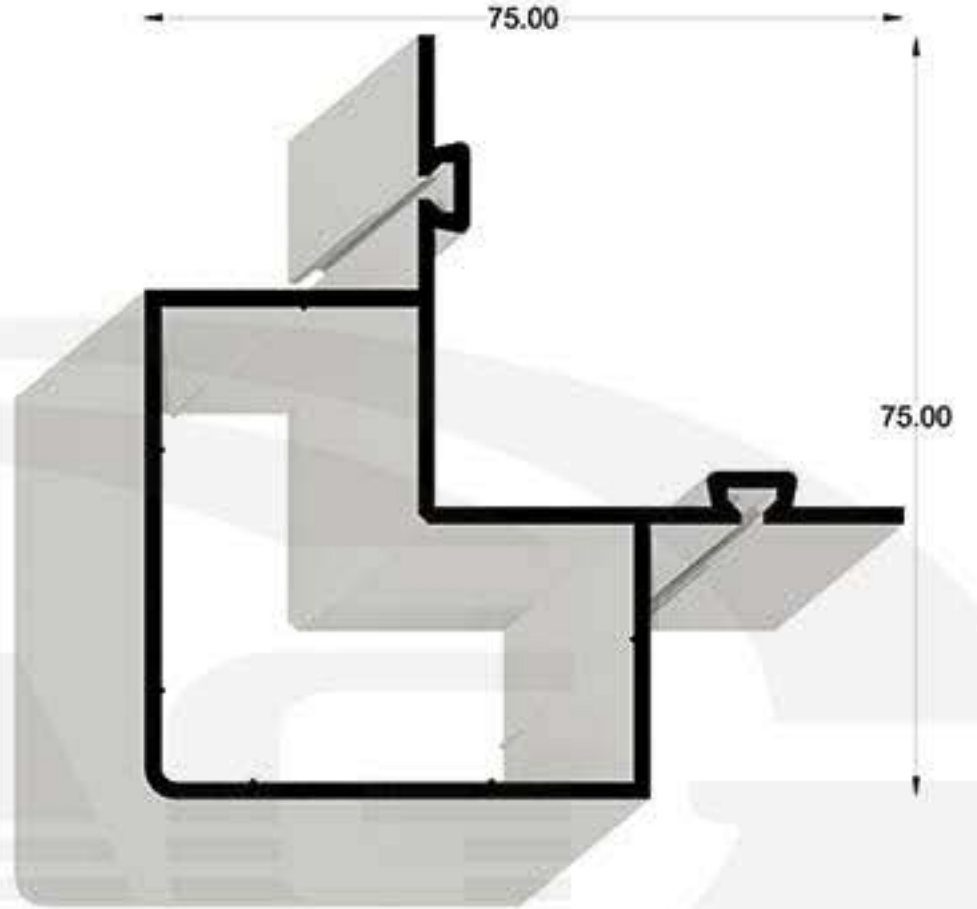

111A-2
1500 gr/m

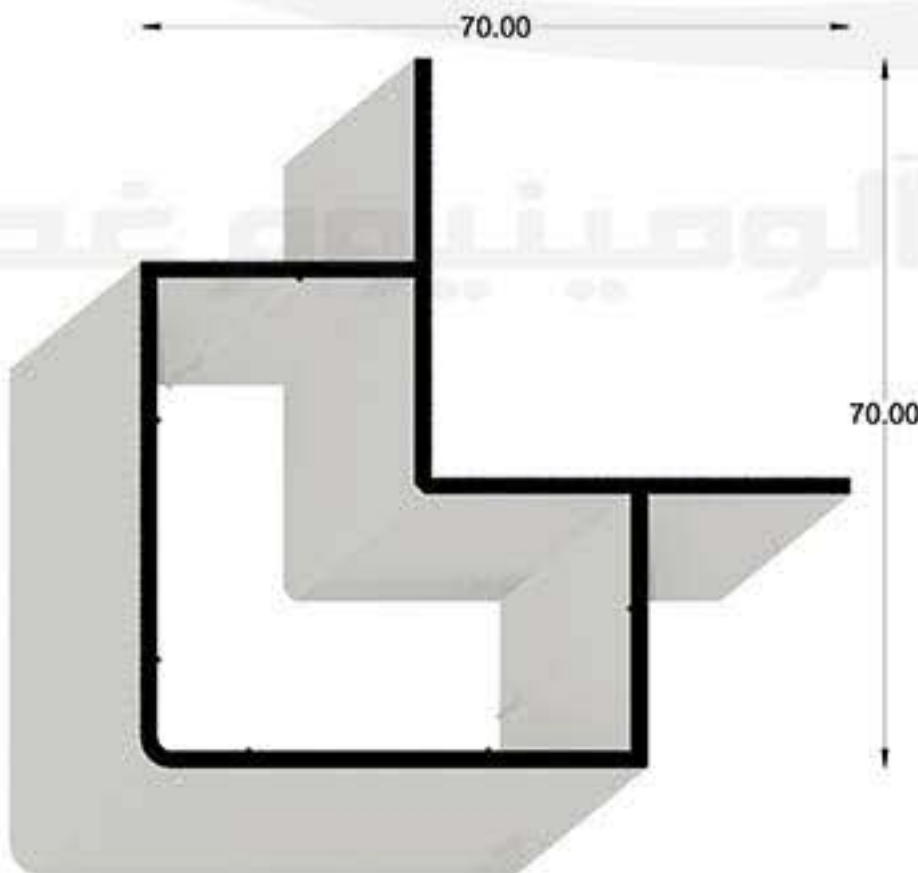

111A-3
1500 gr/m

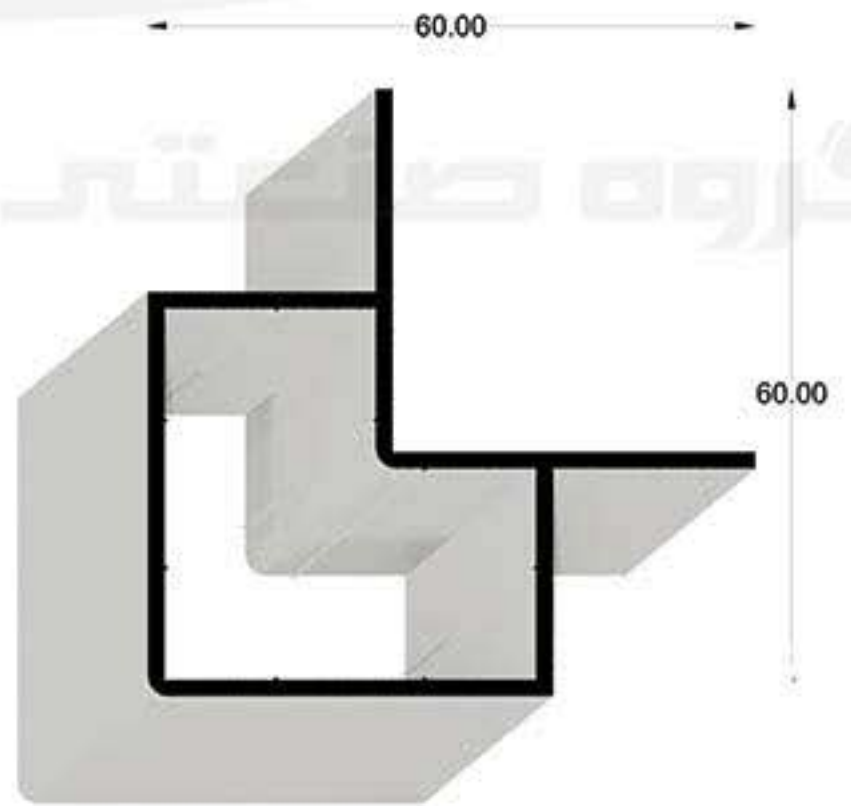

111A-4
1500 gr/m

Ventilation Detail Code 111 (A 1-14)



گروه صنعتی آلومینیوم غدیر

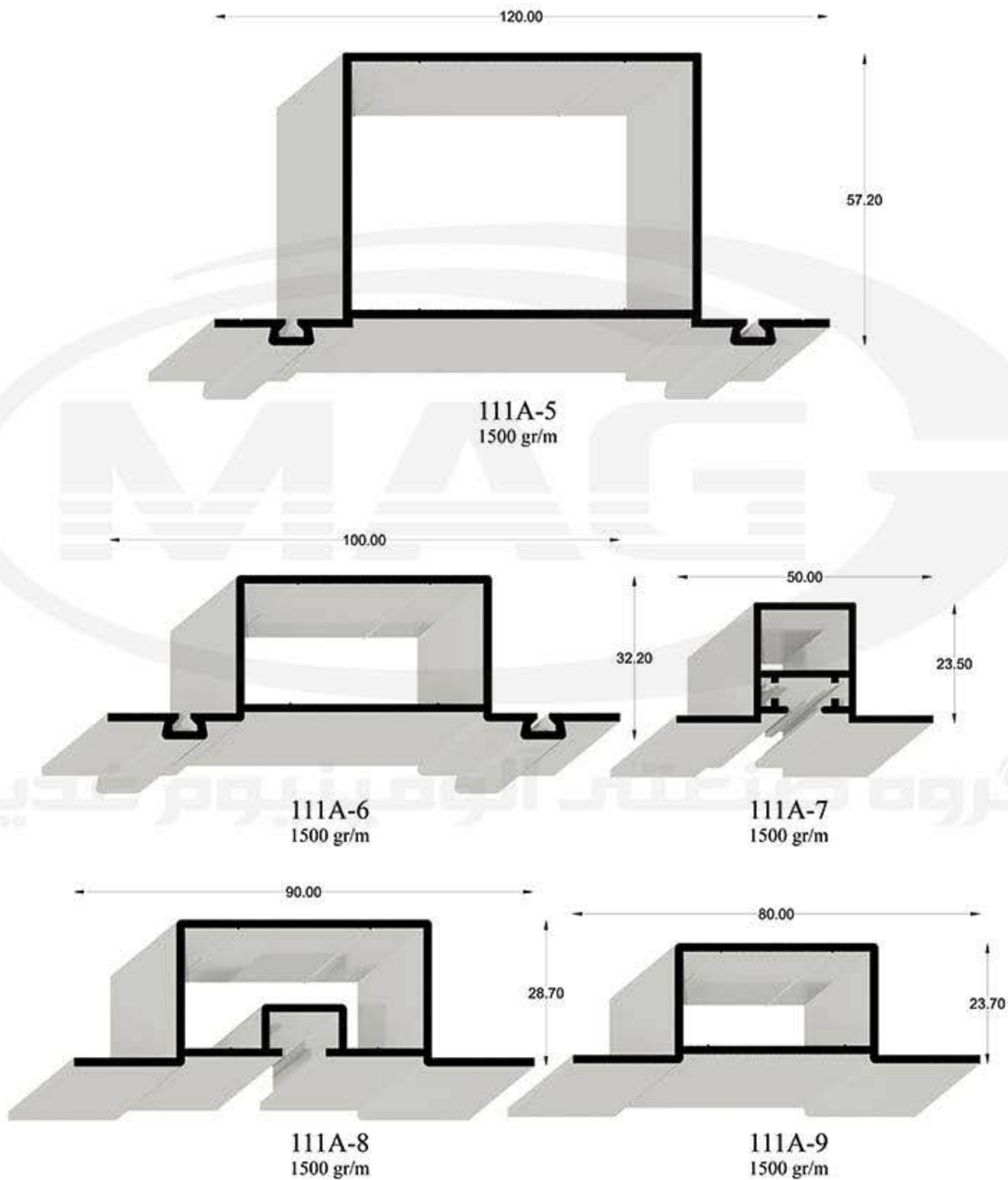

Ventilation Detail Code 111 (A 1-14)

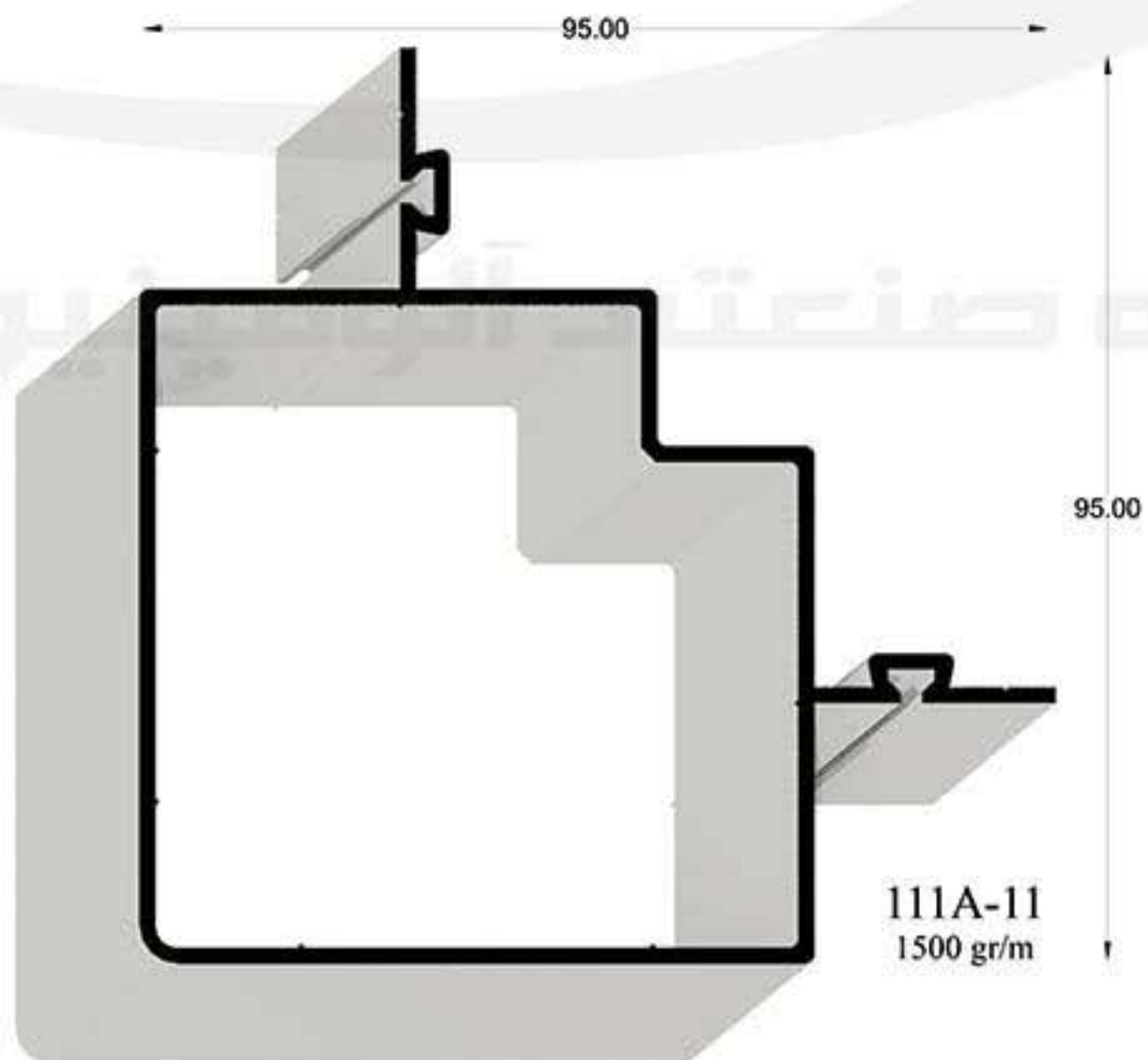
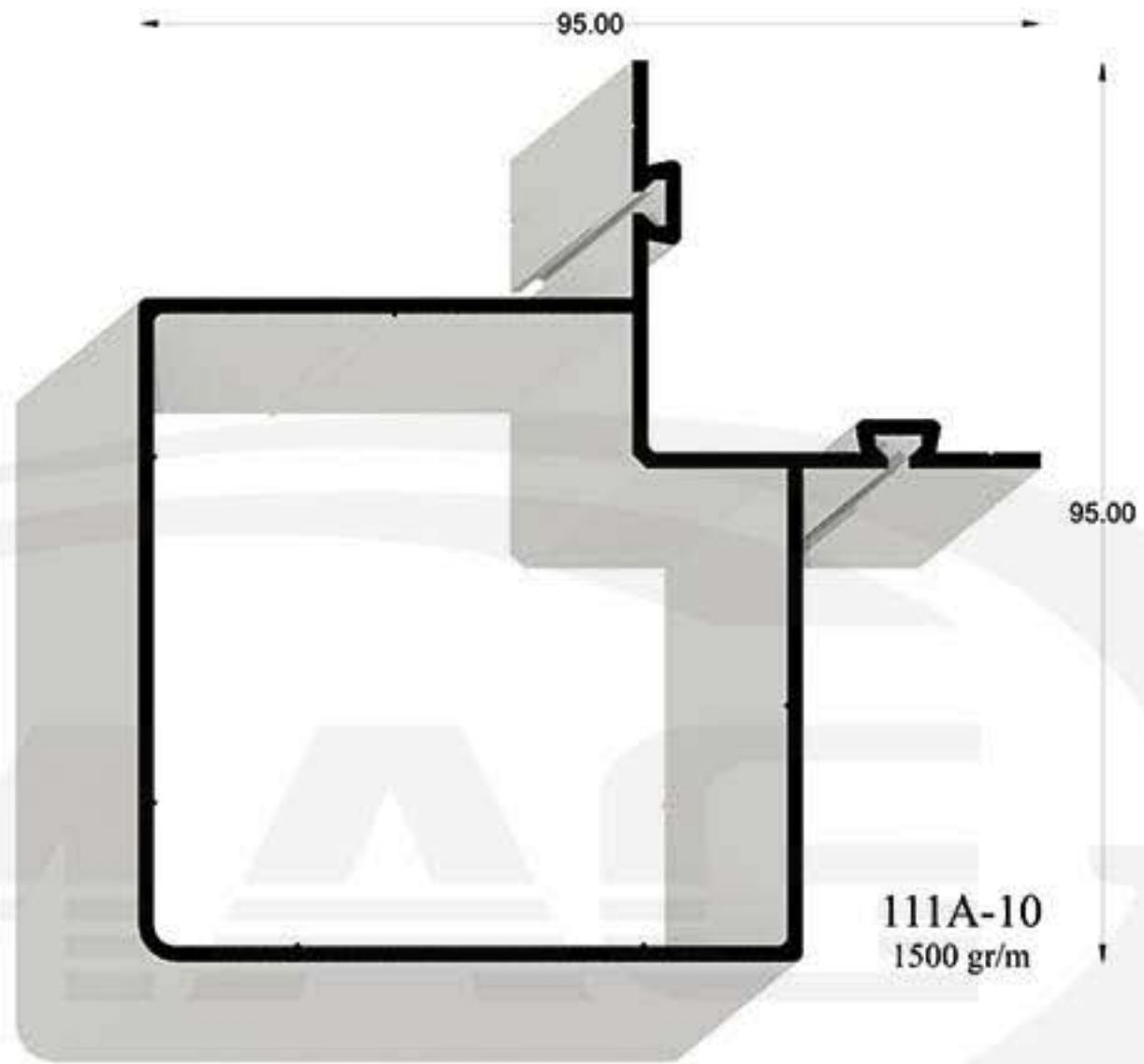

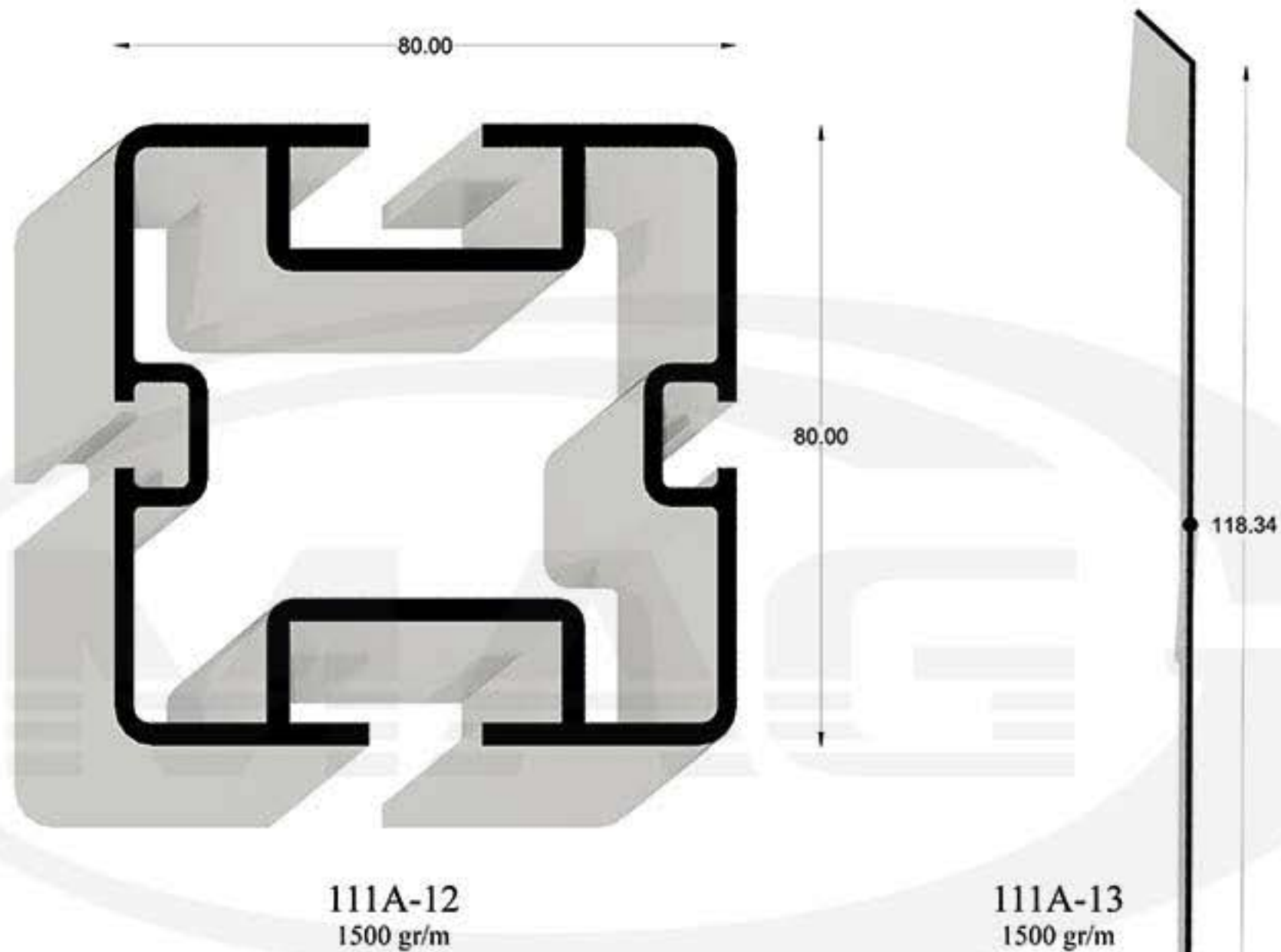

Ventilation Detail Code 111 (B 1-5)

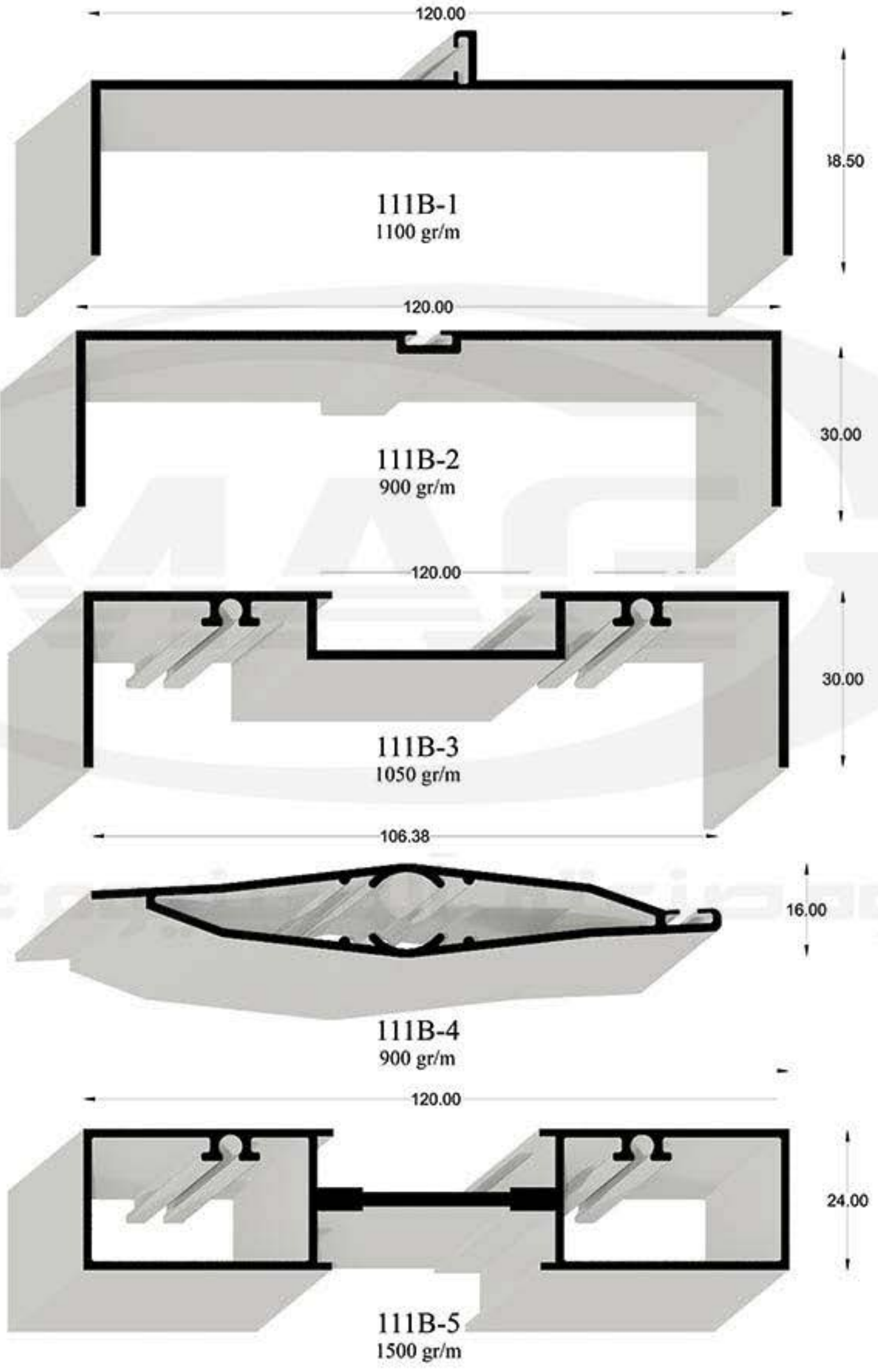

Ventilation Detail Code 111 (C 1-8)



گروه صنعتی آلومینیوم غدیر

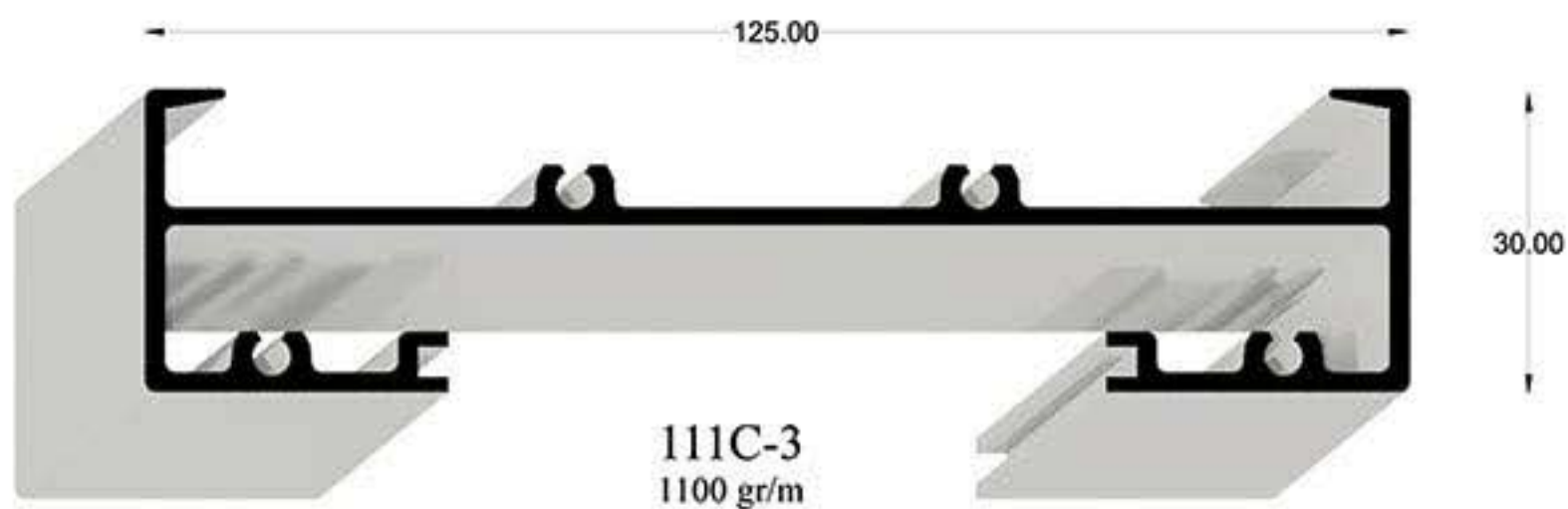
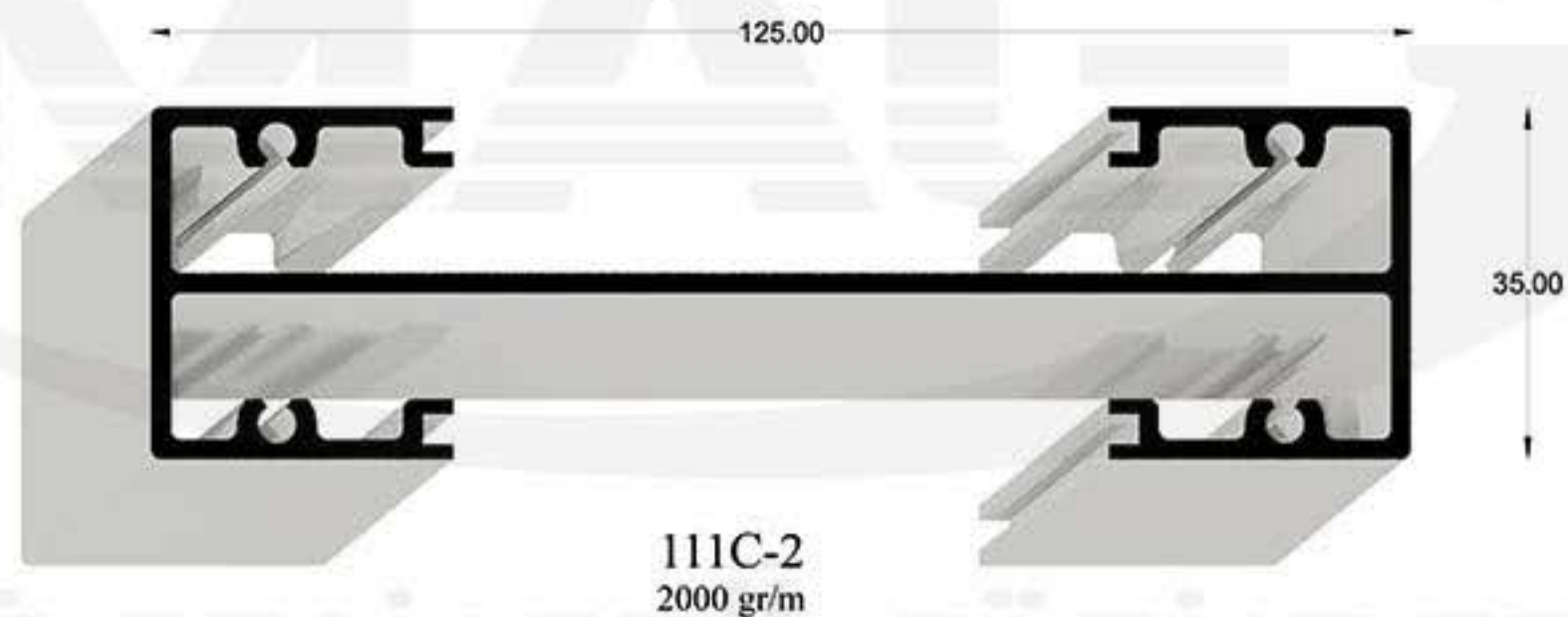
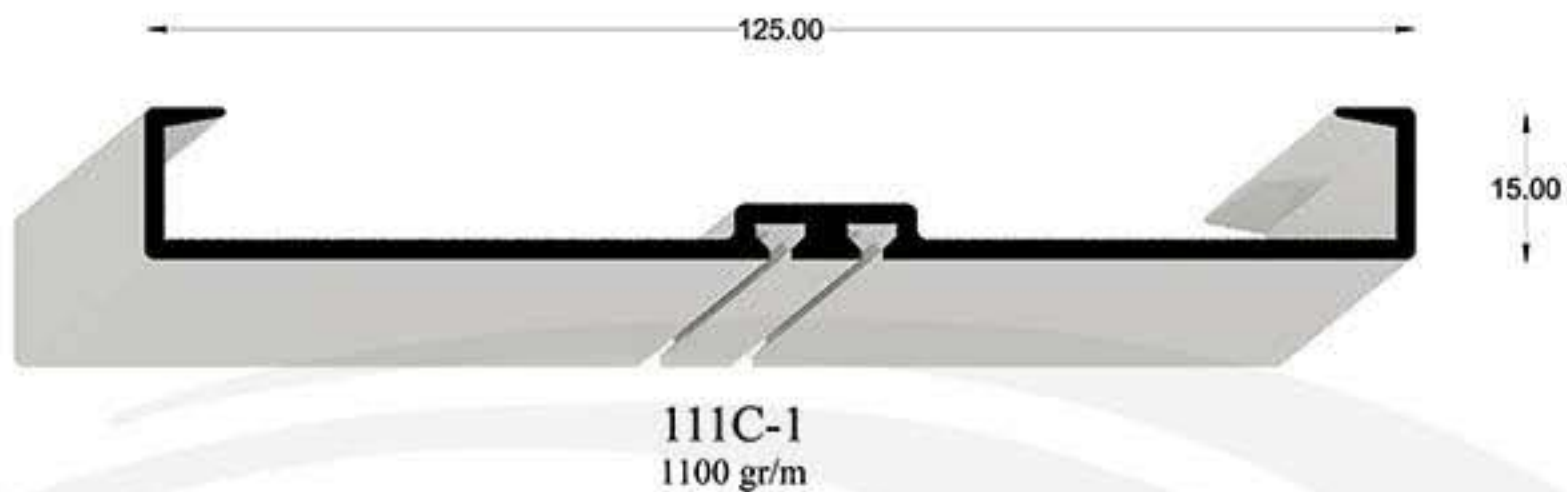

Ventilation Detail Code 111 (C 1-8)

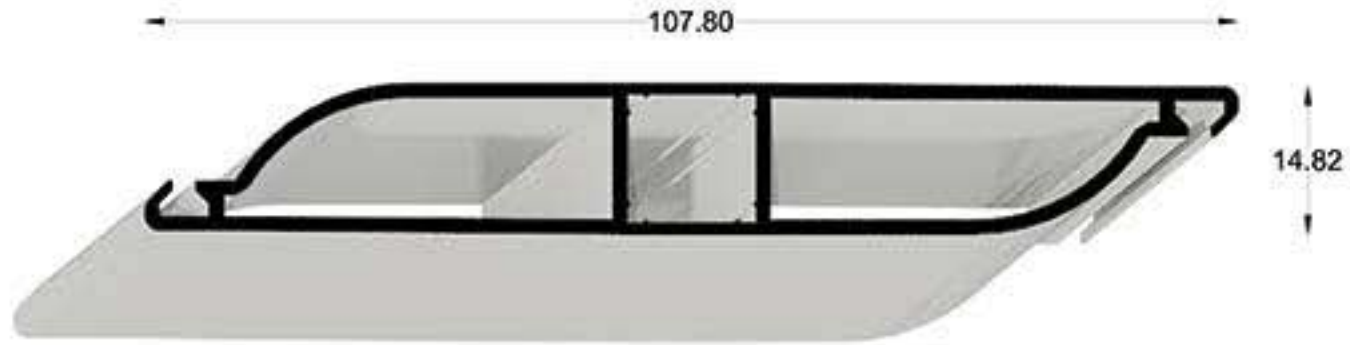

111C-4
1100 gr/m



111C-5
760 gr/m

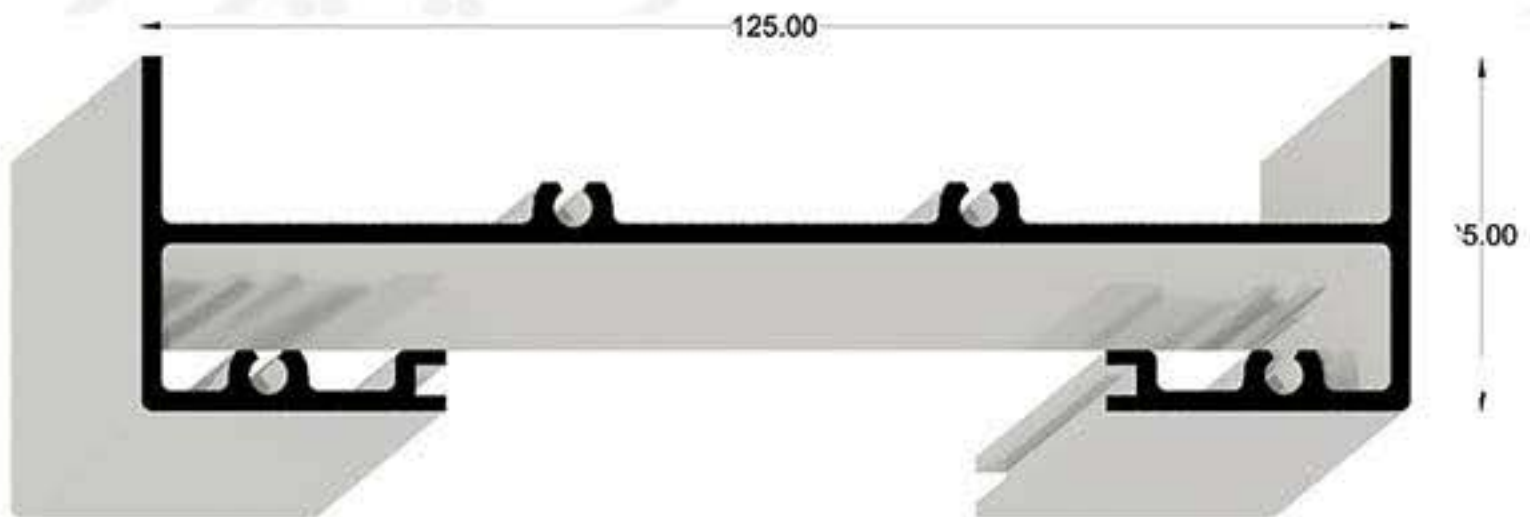

111C-6
1500 gr/m

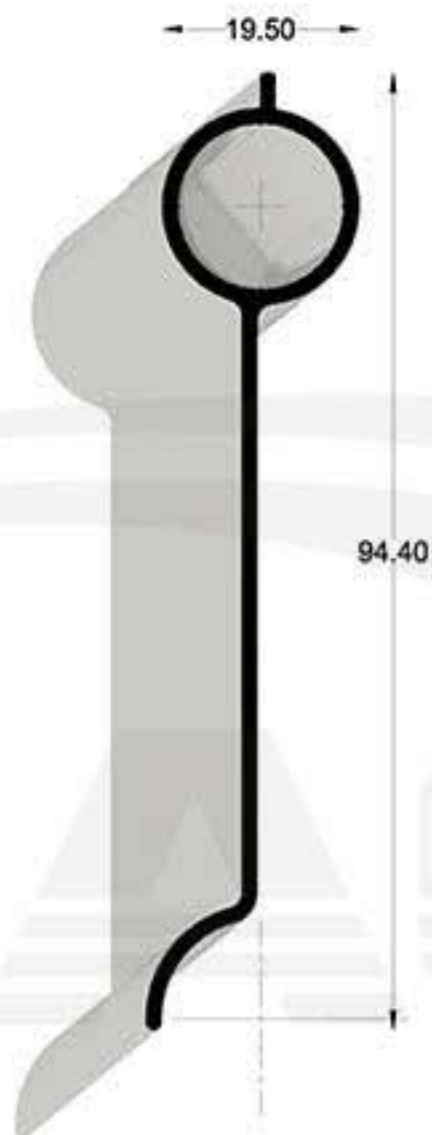

111C-7
760 gr/m

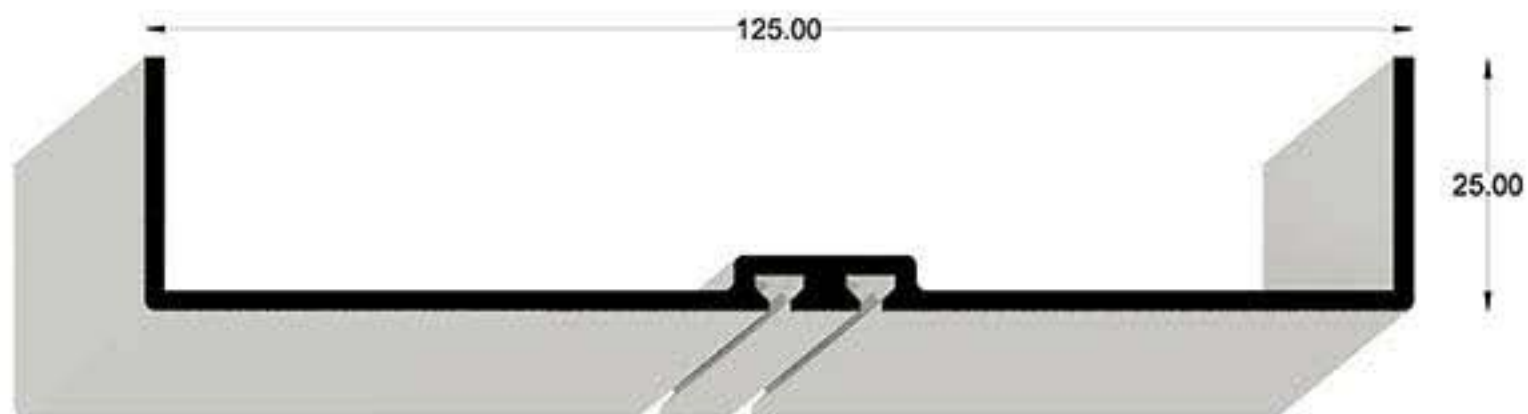

111C-8
1000 gr/m



GHADIR ALUMINIUM IND. GROUP

Ventilation Detail Code 111 A,B,C

