

## Ventilation Detail Code 111 (A 1-14)

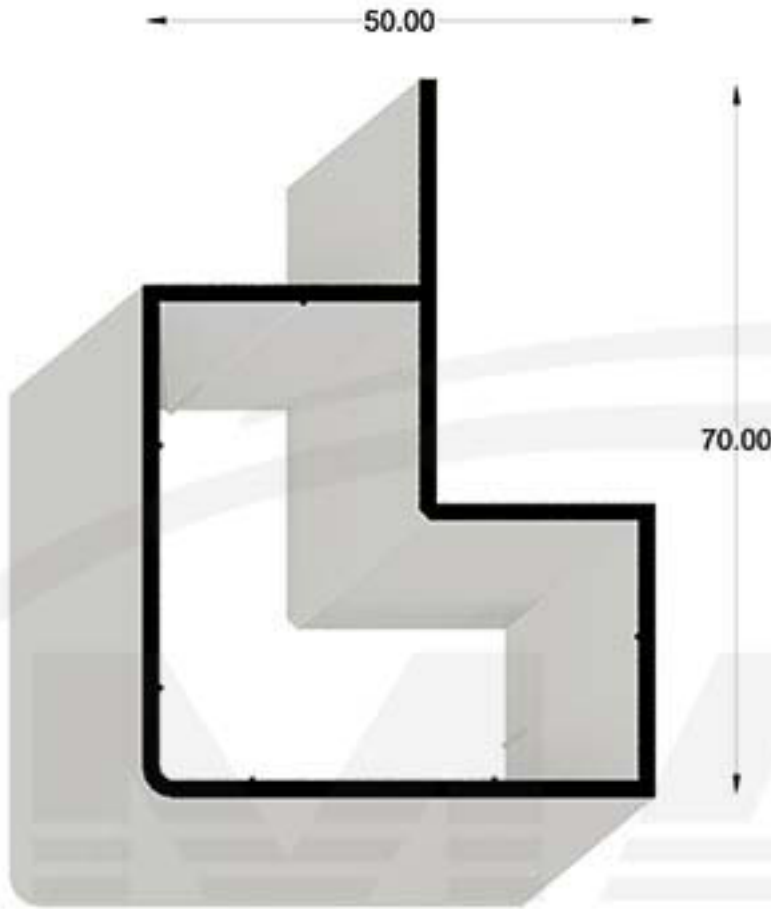

111A-1  
1500 gr/m

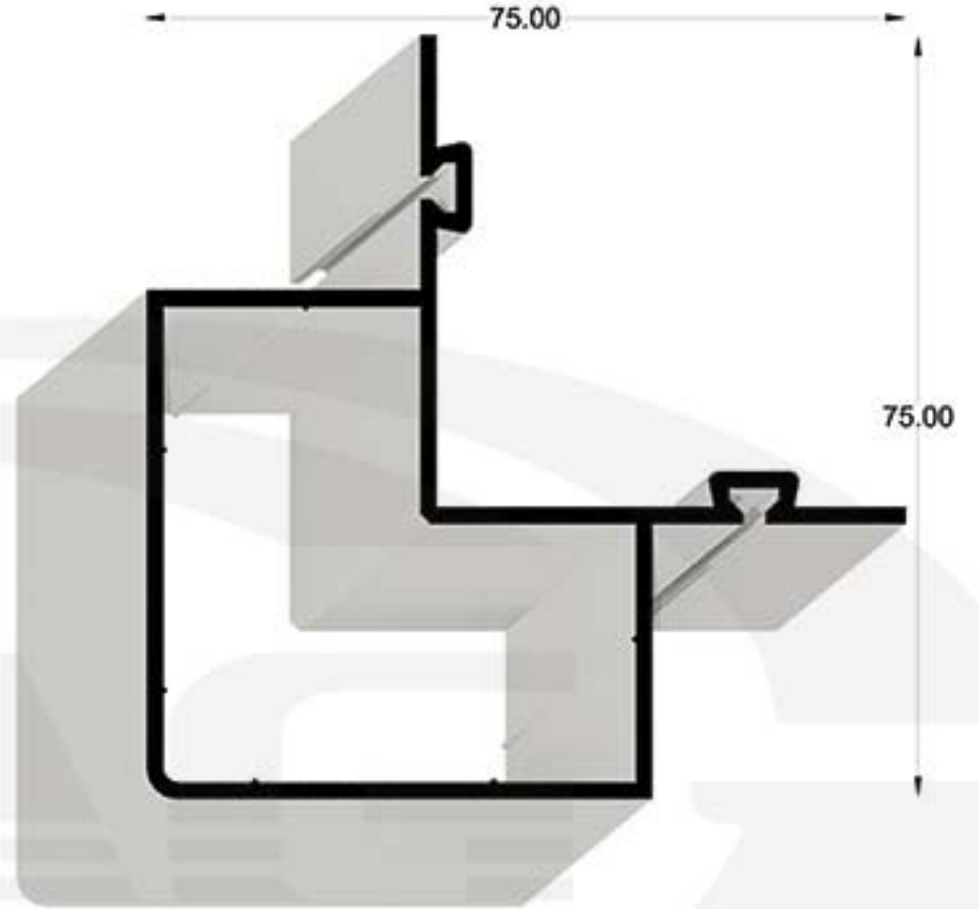

111A-2  
1500 gr/m

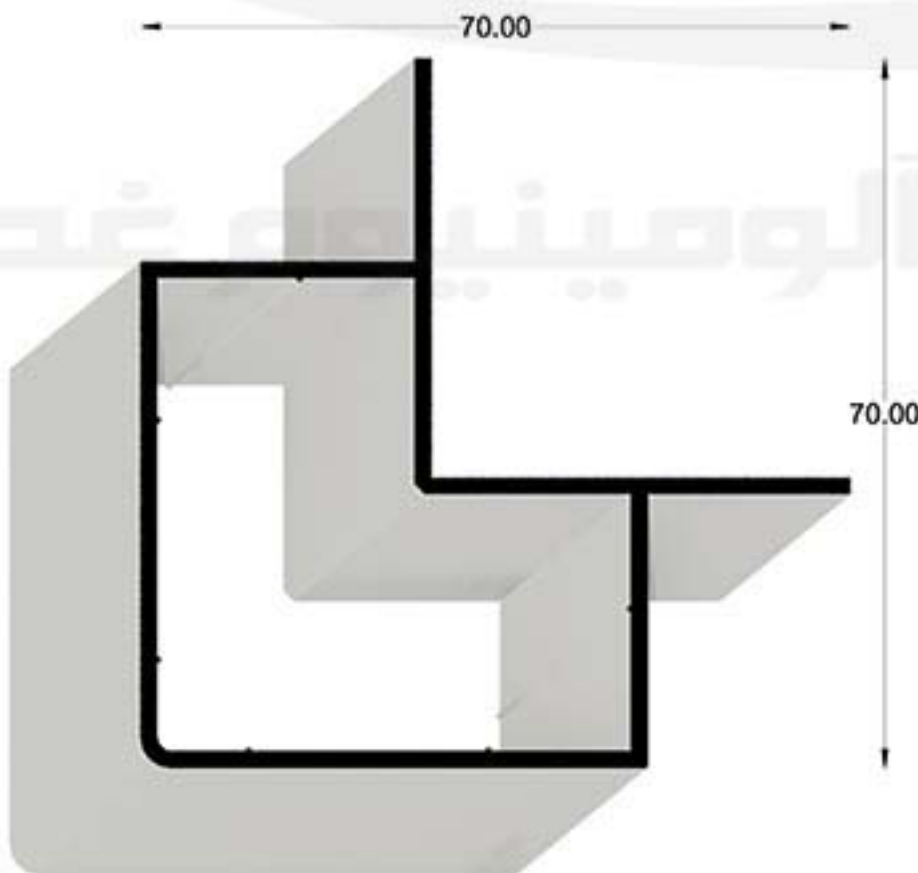

111A-3  
1500 gr/m

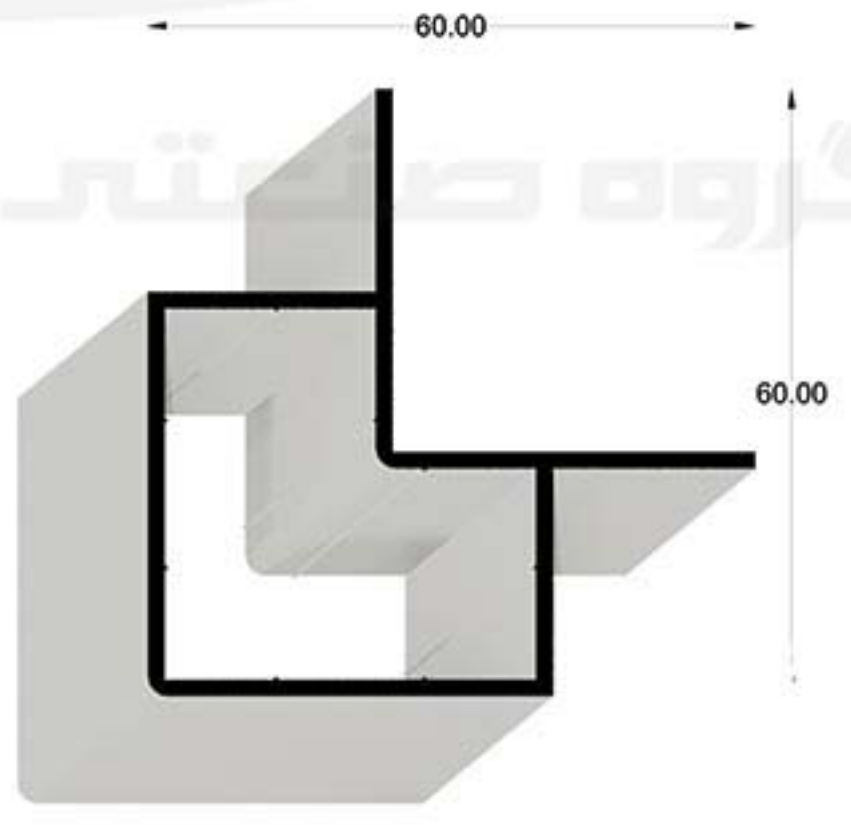

111A-4  
1500 gr/m

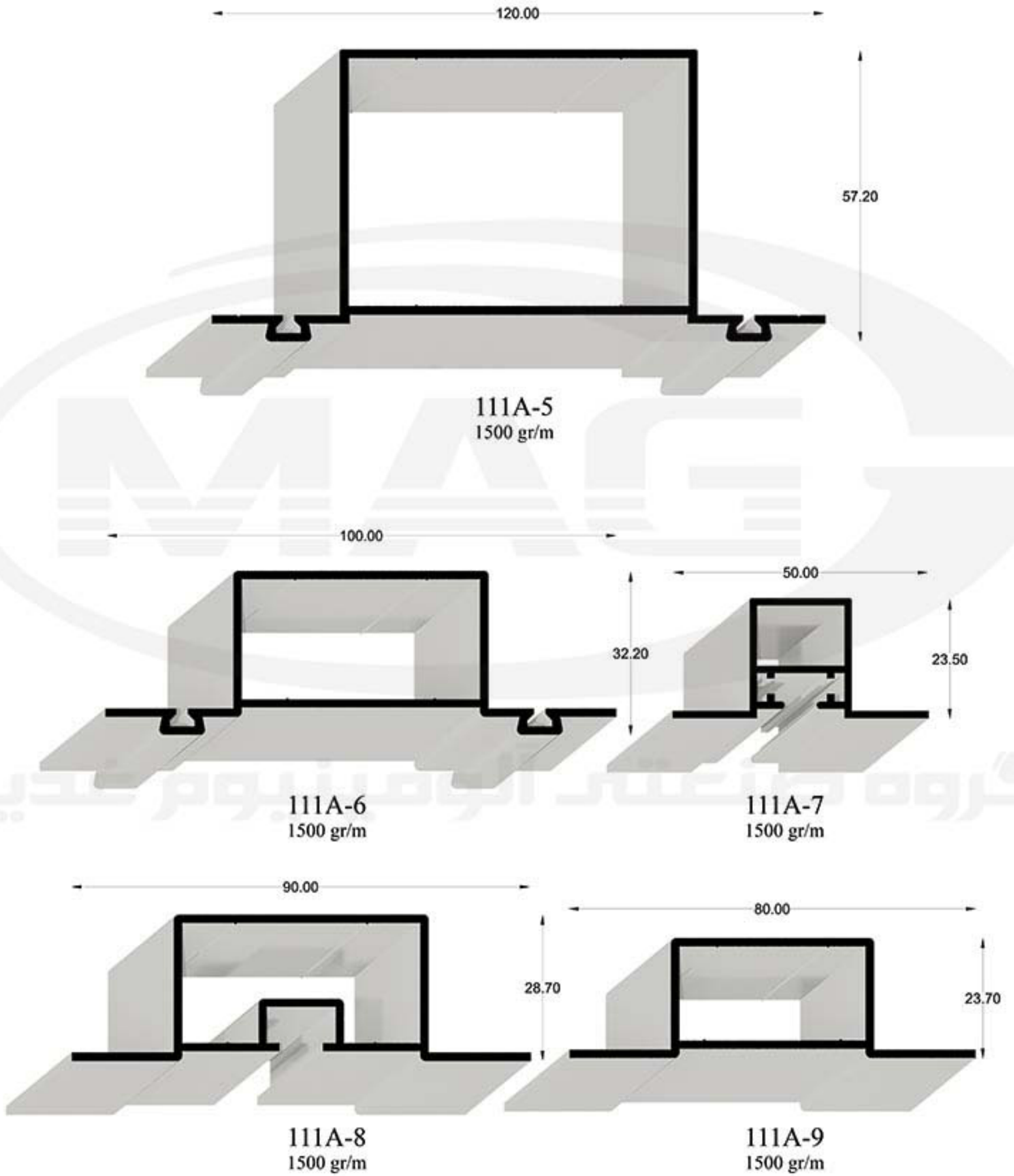

## Ventilation Detail Code 111 (A 1-14)

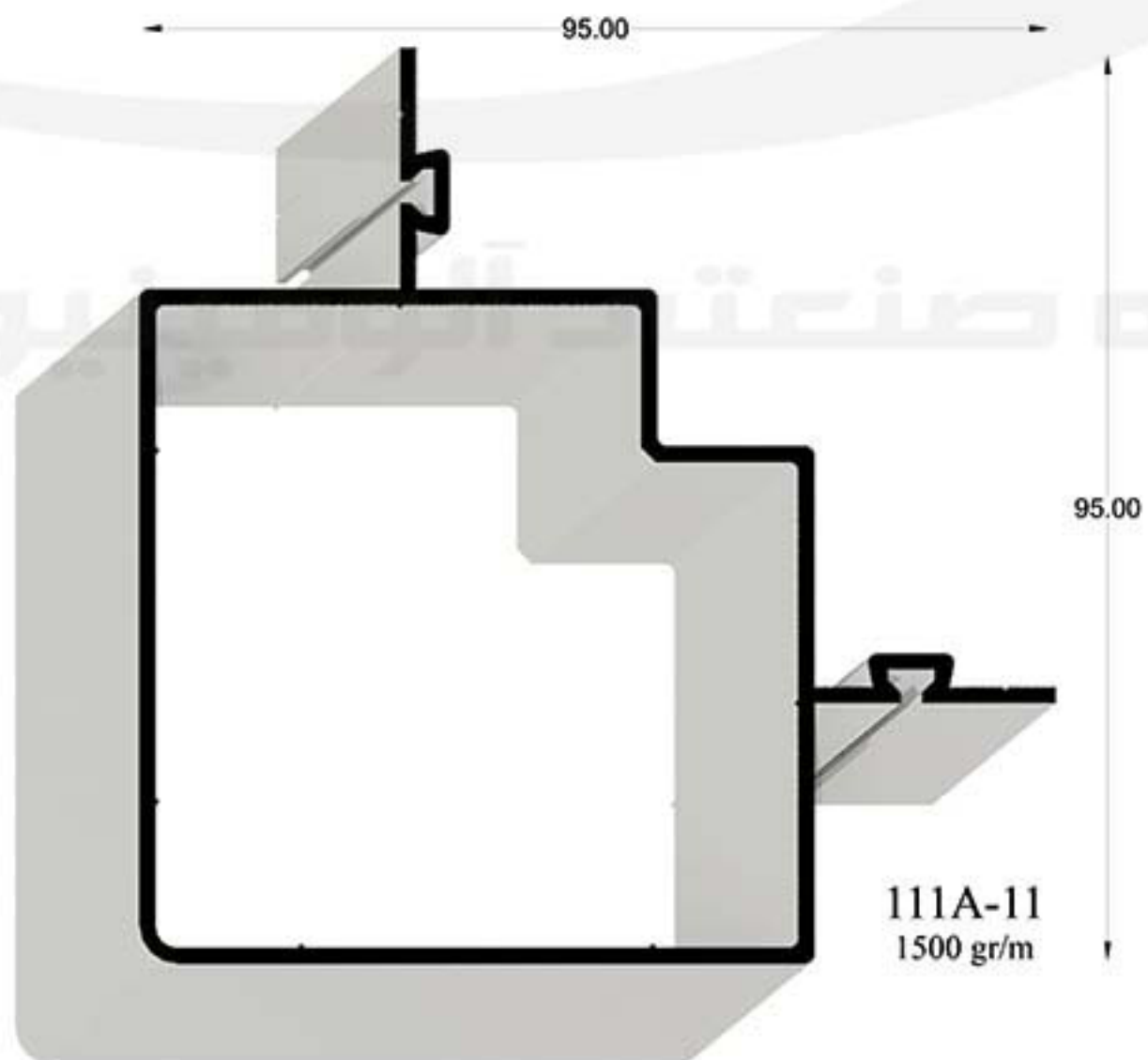
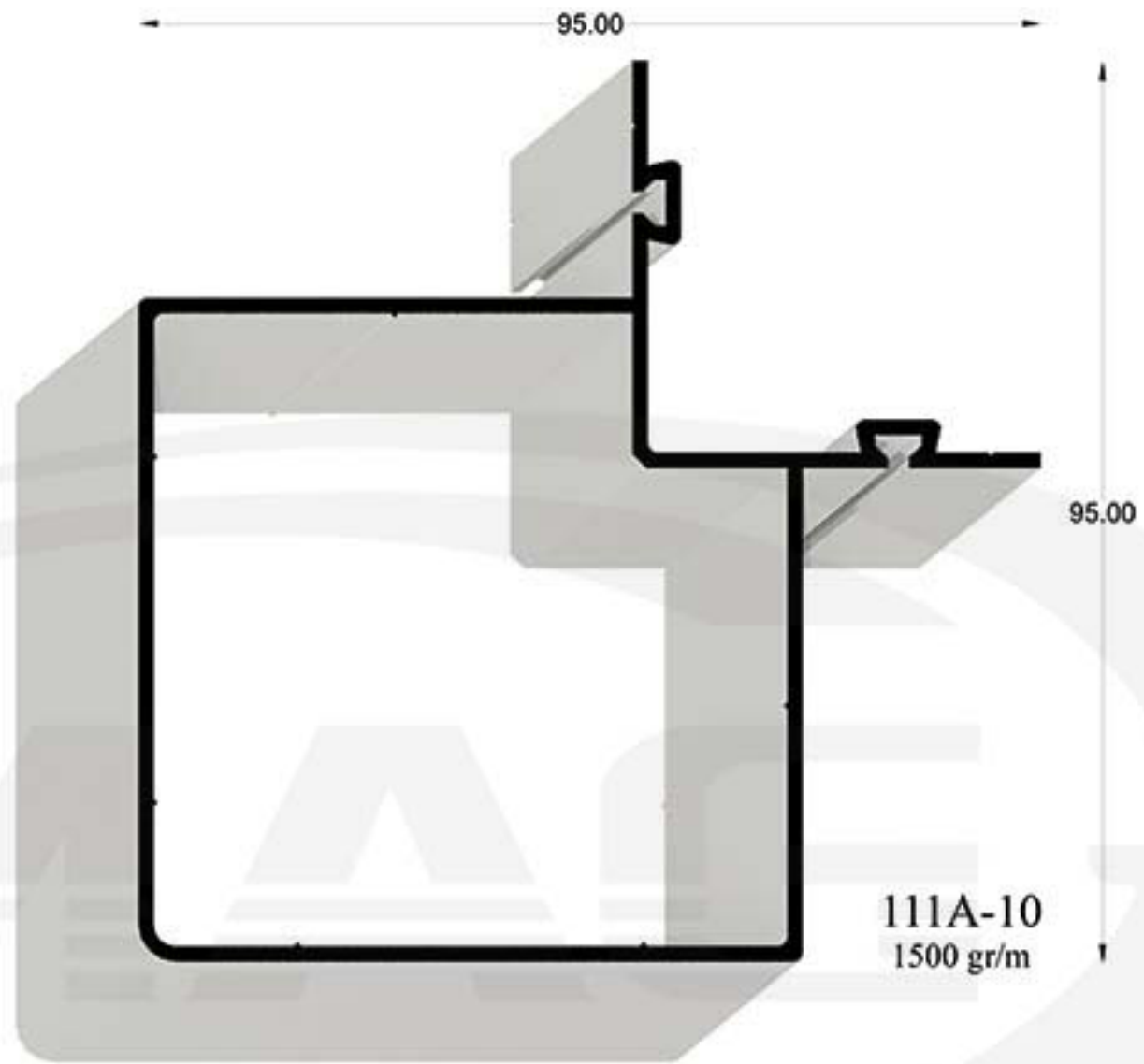



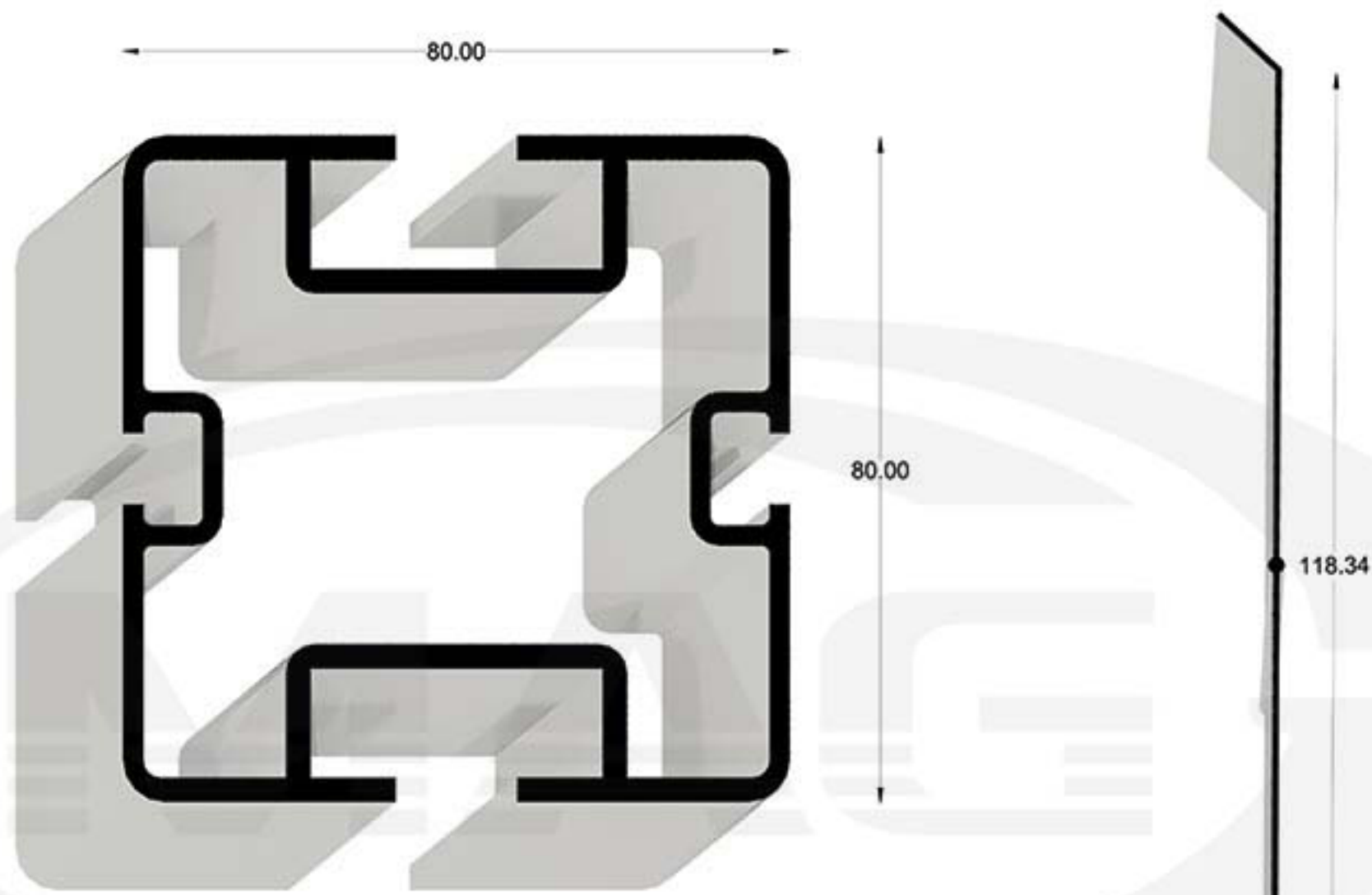

111A-12  
1500 gr/m

111A-13  
1500 gr/m

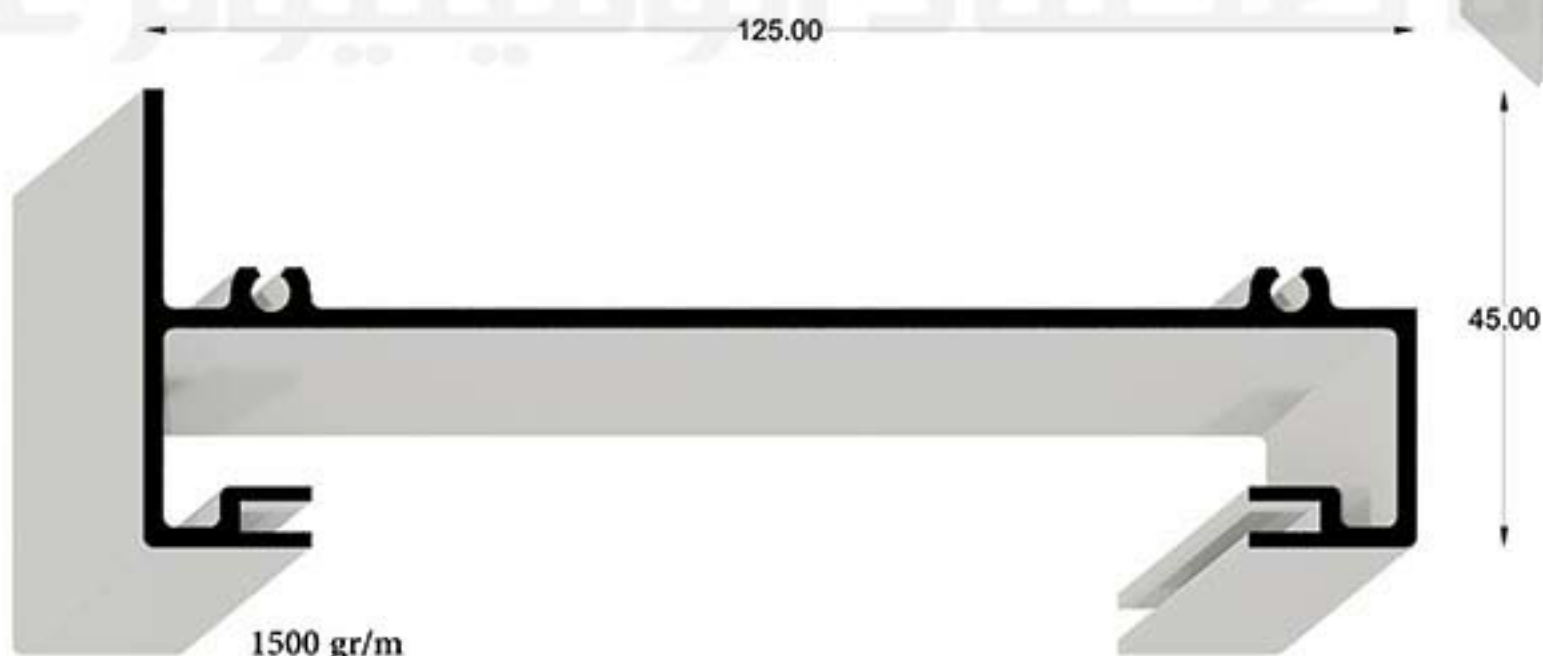

1500 gr/m

111A-14  
1500 gr/m

## Ventilation Detail Code 111 (B 1-5)

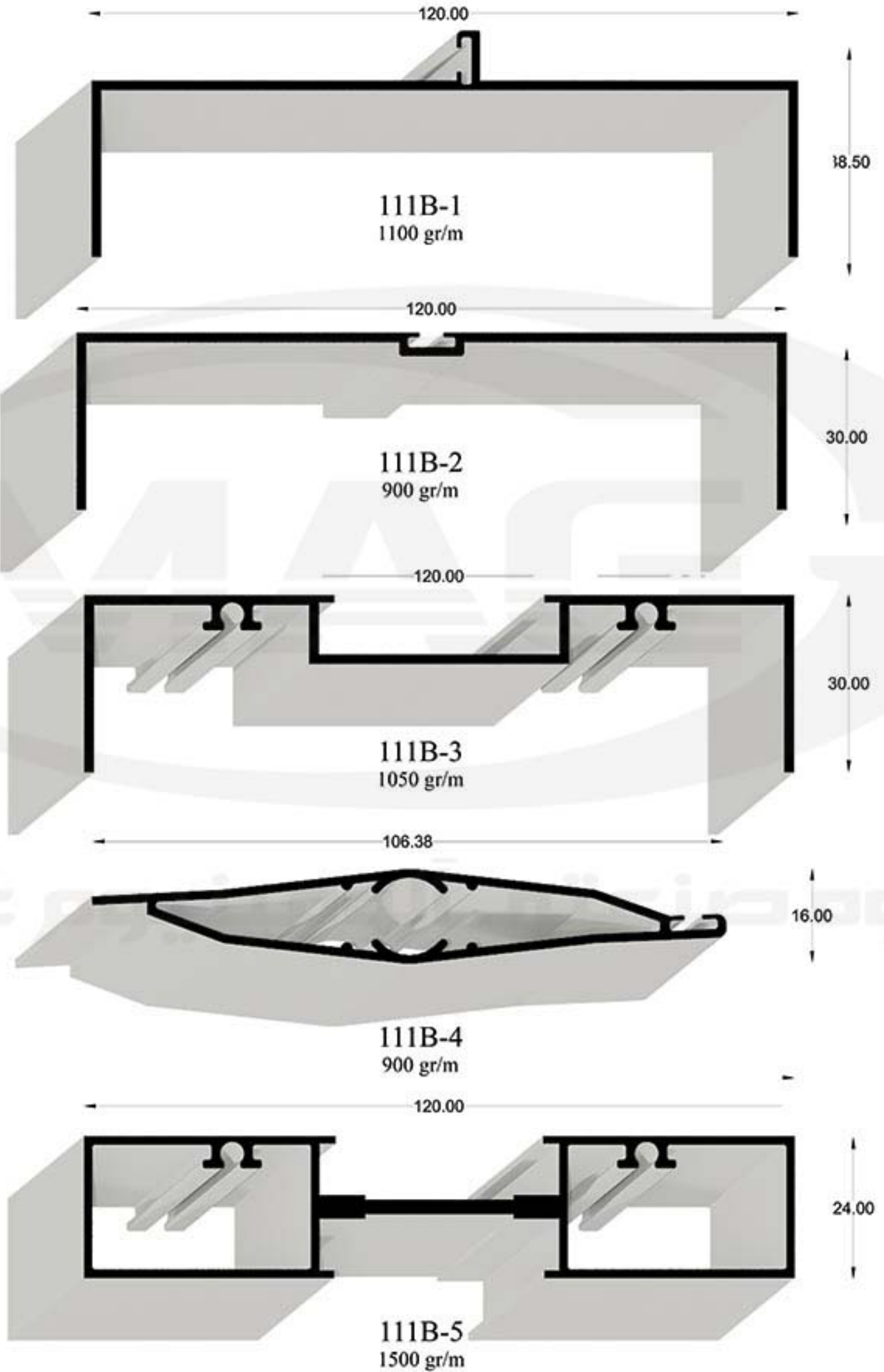

# Ventilation Detail Code 111 (C 1-8)



گروه صنعتی آلومینیوم غدیر

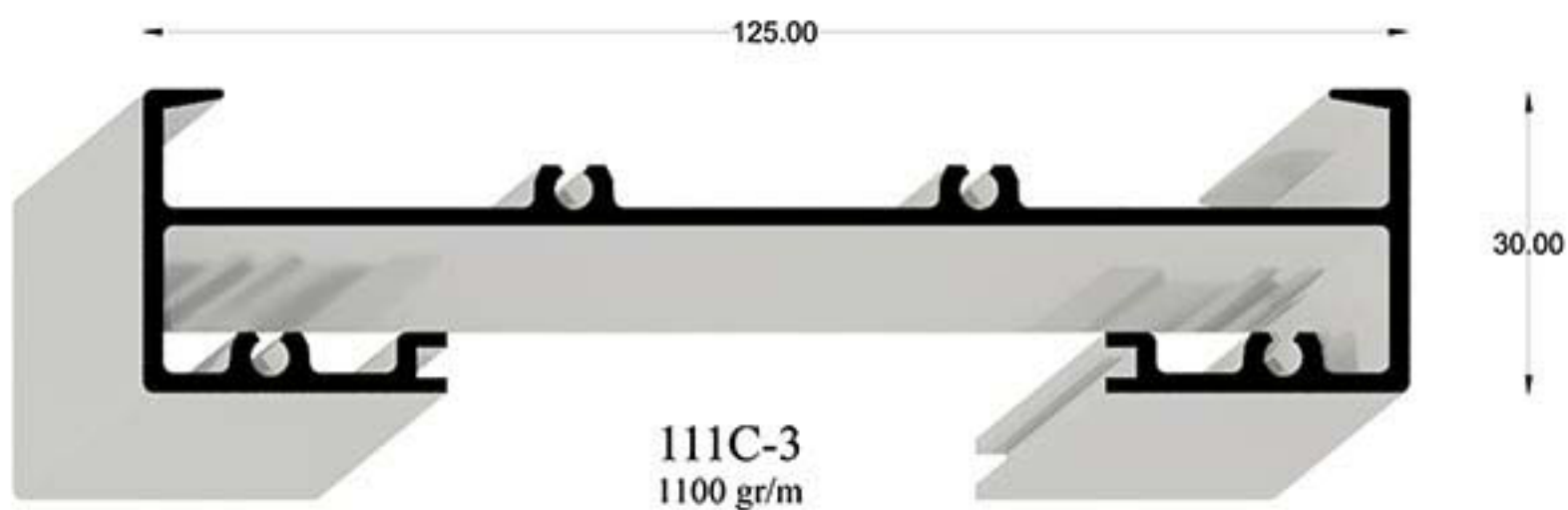
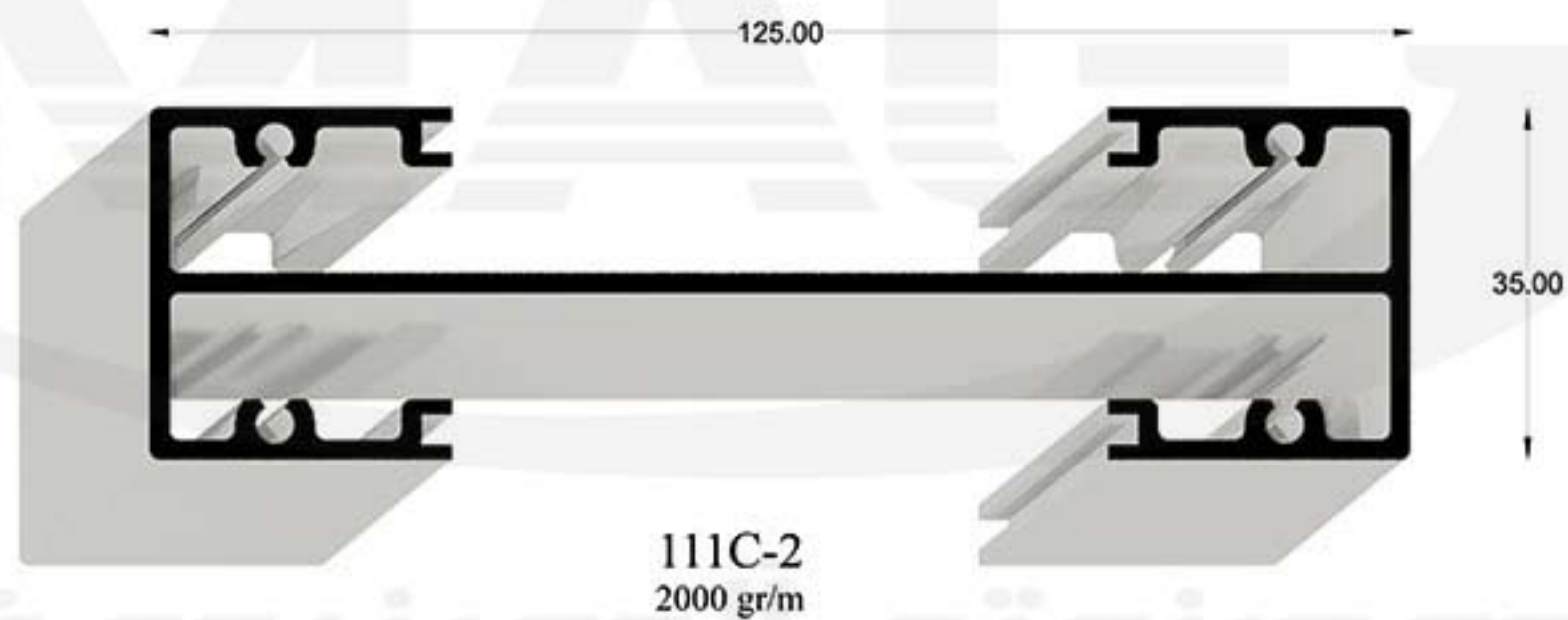
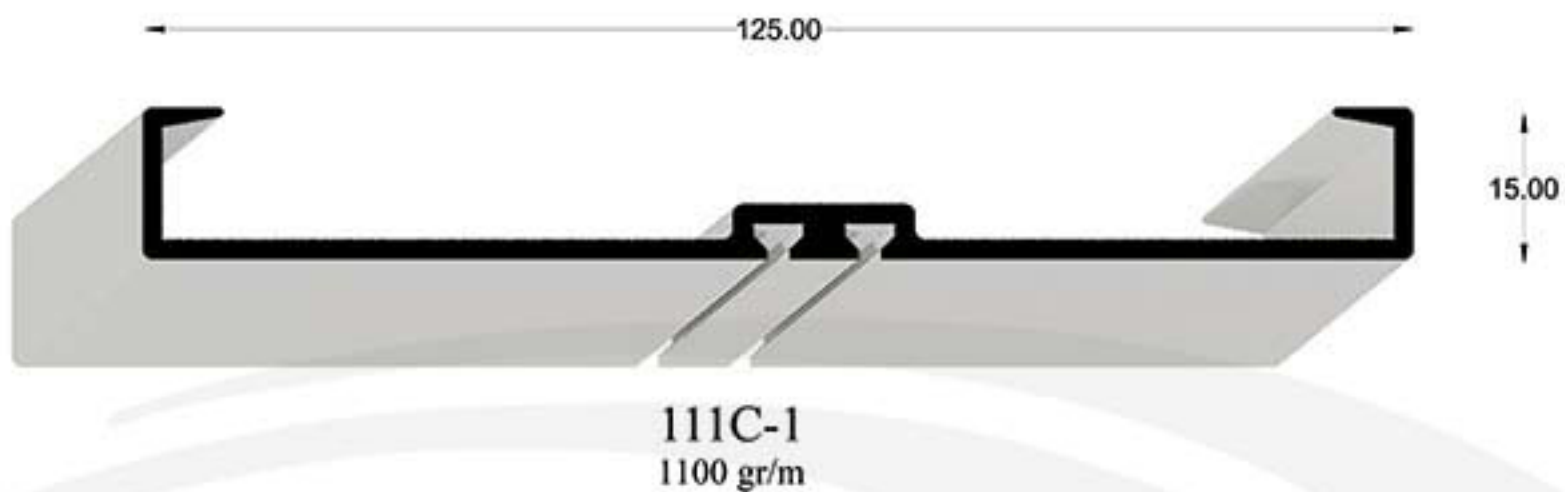

## Ventilation Detail Code 111 (C 1-8)

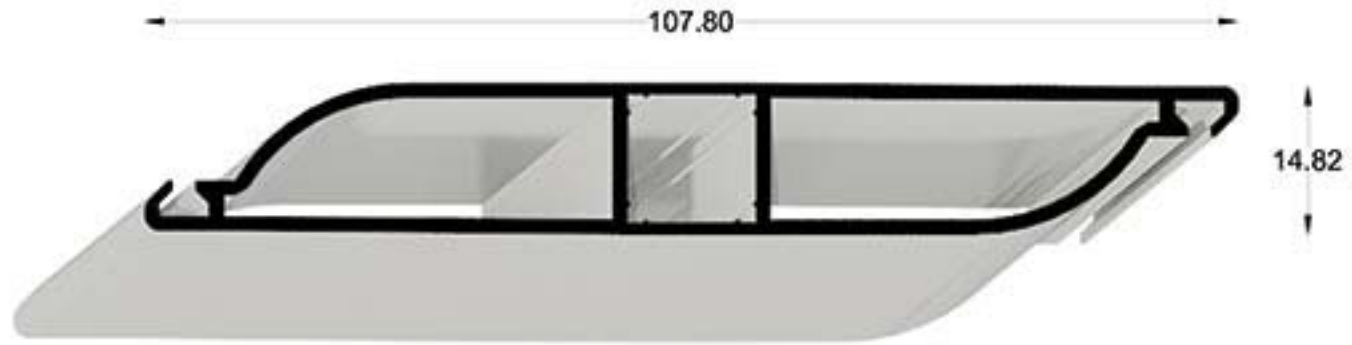

111C-4  
1100 gr/m



111C-5  
760 gr/m

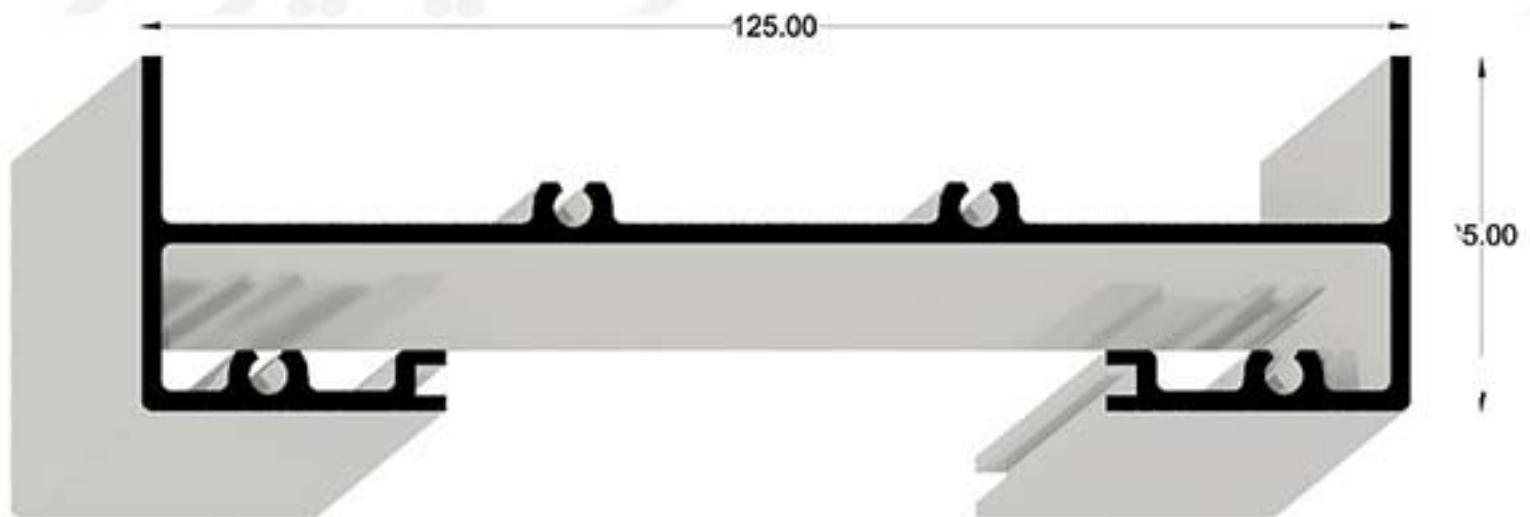

111C-6  
1500 gr/m



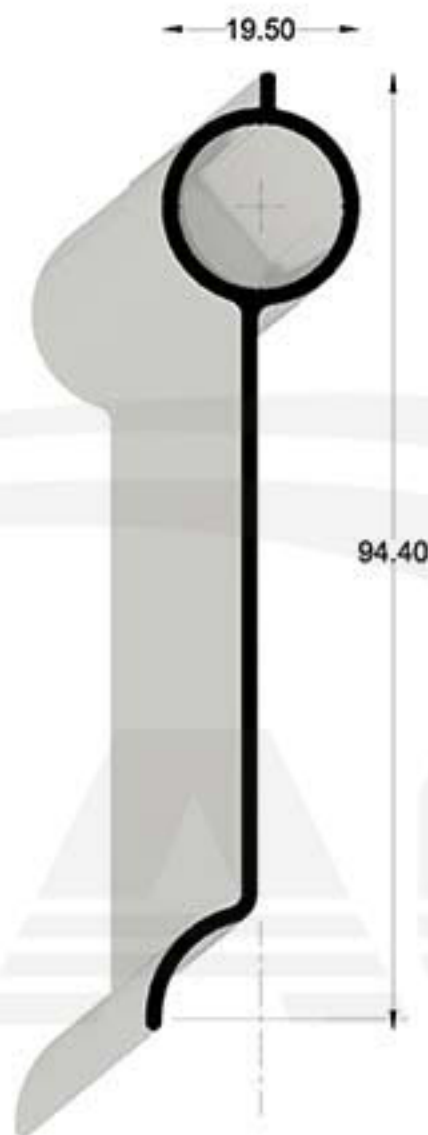

111C-7  
760 gr/m

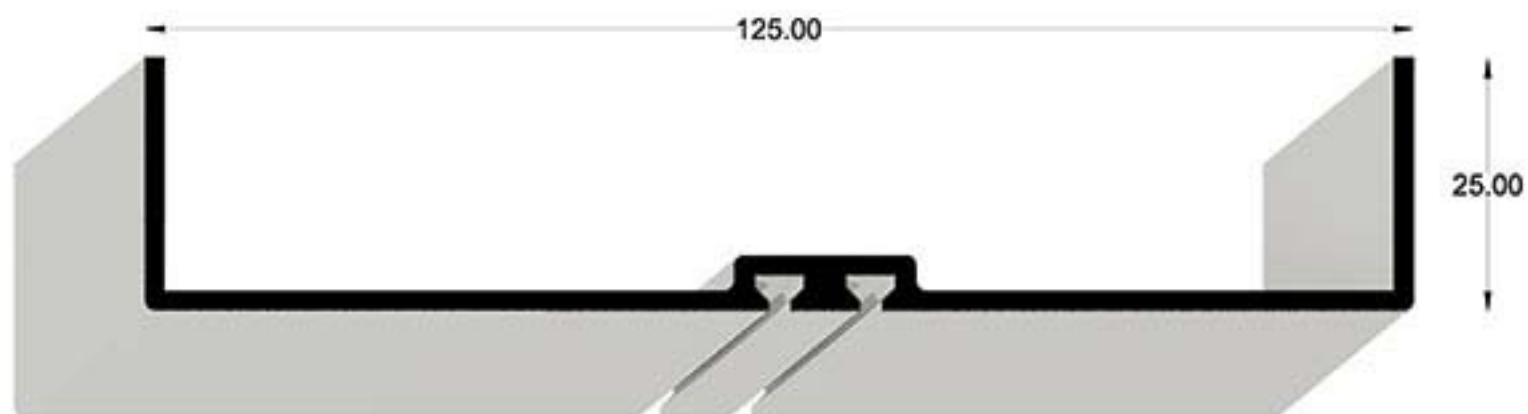

111C-8  
1000 gr/m



GHADIR ALUMINIUM IND. GROUP

## Ventilation Detail Code 111 A,B,C

