



Code:103C

سیستم درب
کریه ای ماشین

Automobil Shutters
Door System

Page: 140



Code:103A

سیستم درهای اتومات

Automatic door System

Page: 126



Code:103B

سیستم درهای
کریه برقی

Electric Shutters
Door System

Page: 132





Automatic Doors System

GHADIR ALUMINIUM IND. GROUP



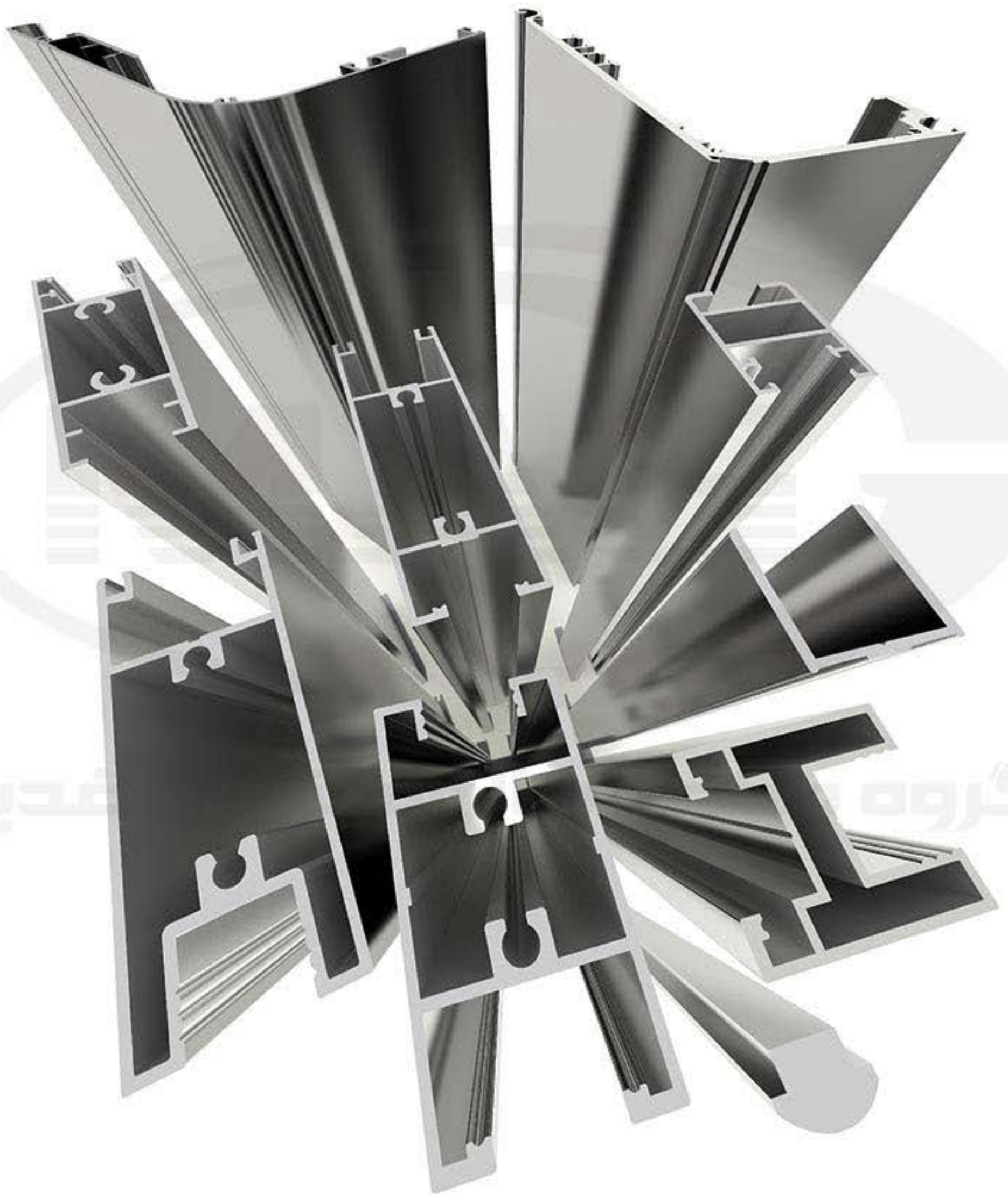

Code:103A

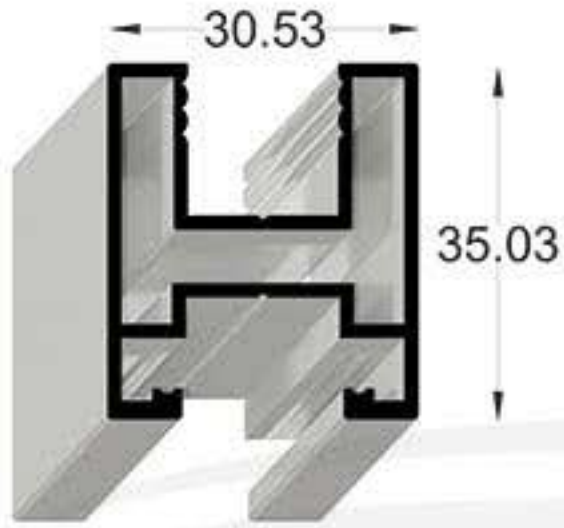

103A-1
685 gr/m

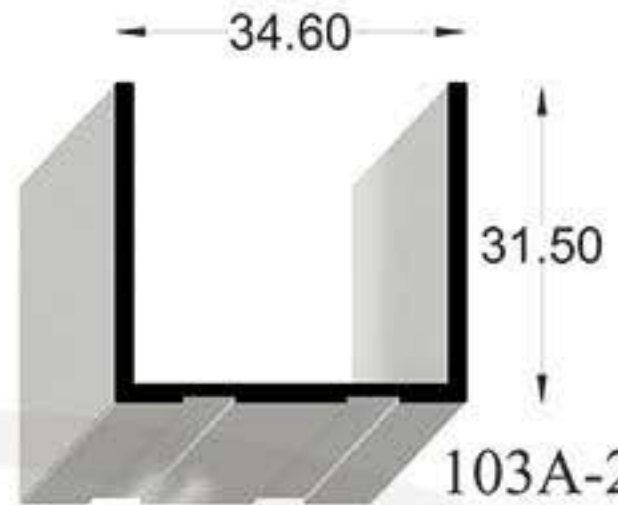

103A-2
464 gr/m

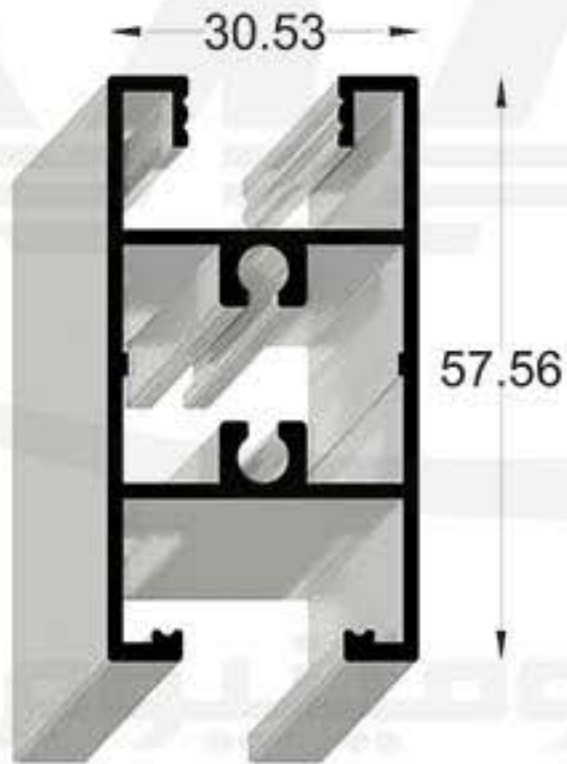

103A-3
1020 gr/m

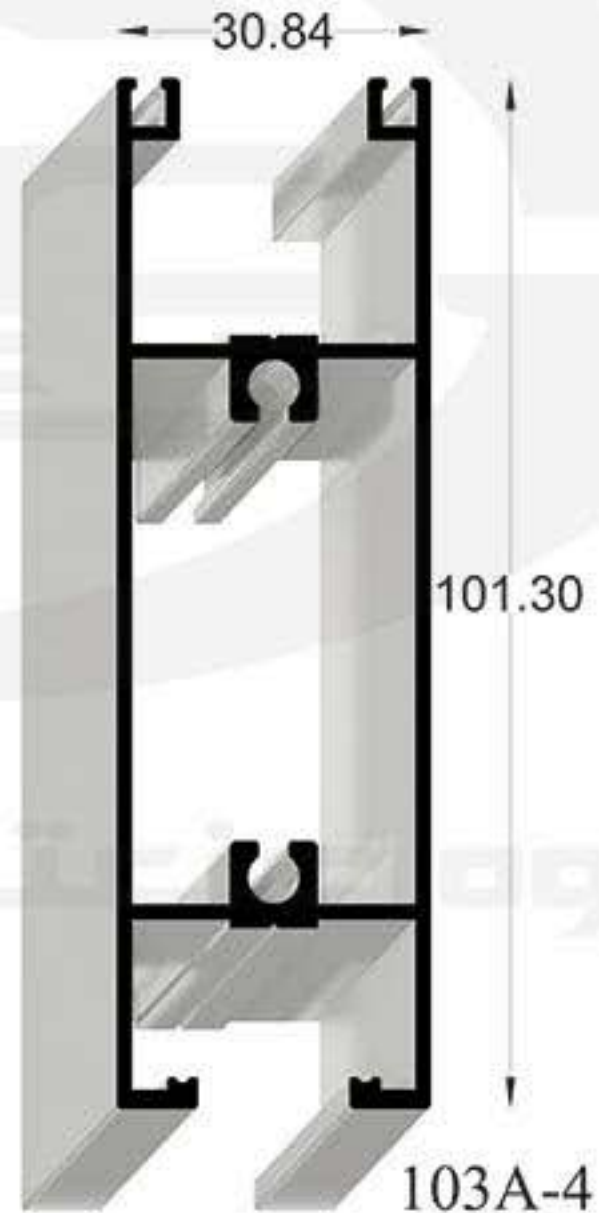

103A-4
1410 gr/m



103A-5
920 gr/m

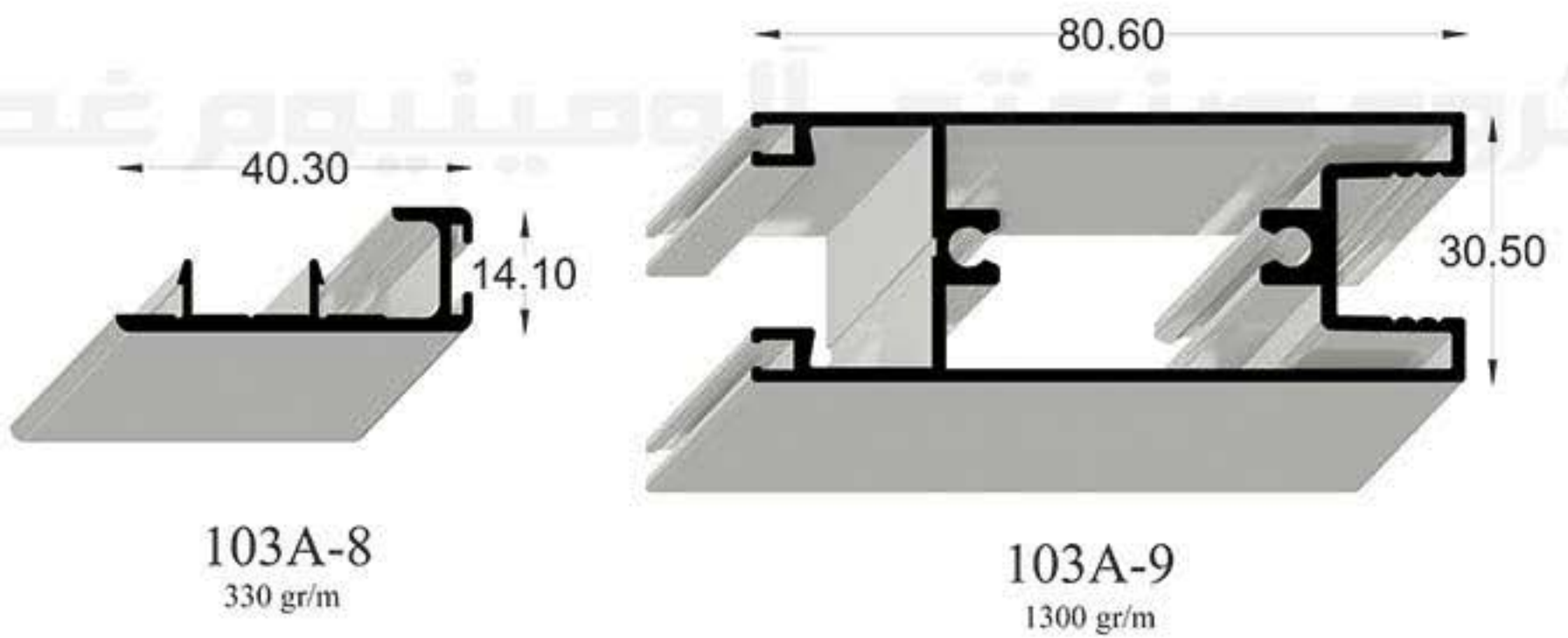
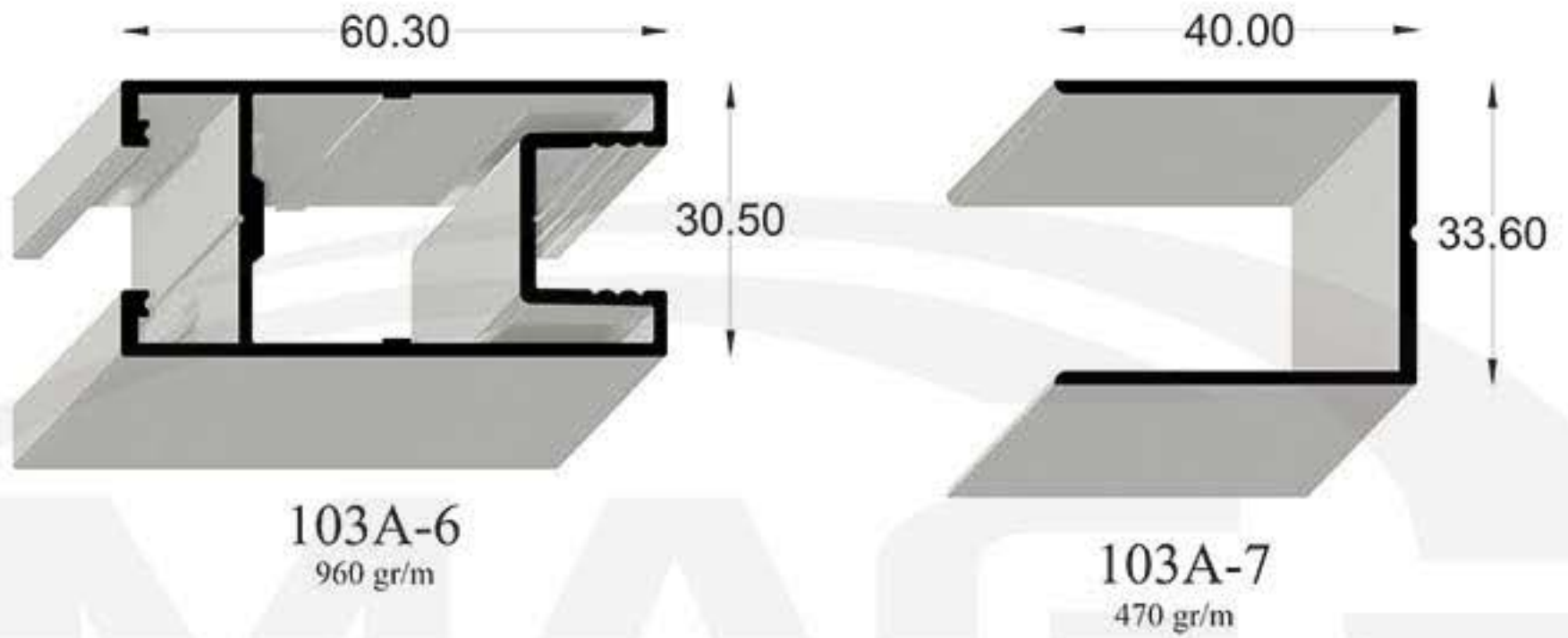

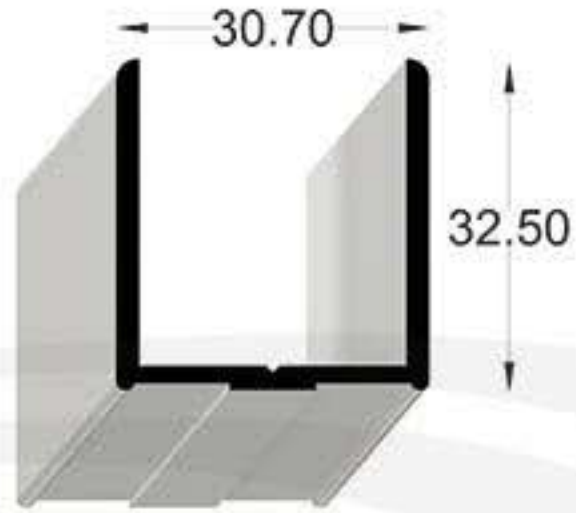

103A-10
520 gr/m

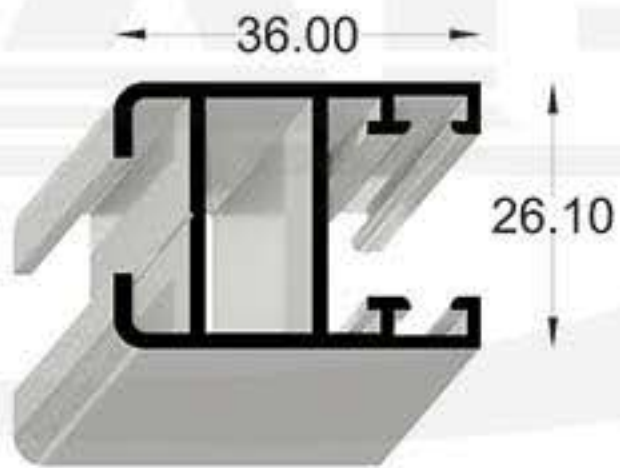

103A-11
600 gr/m

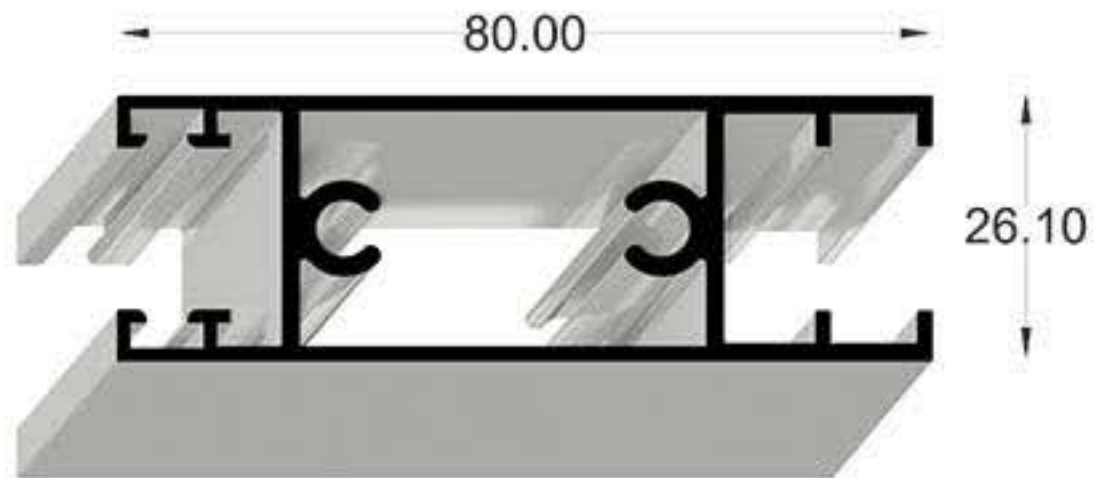

103A-12
1210 gr/m

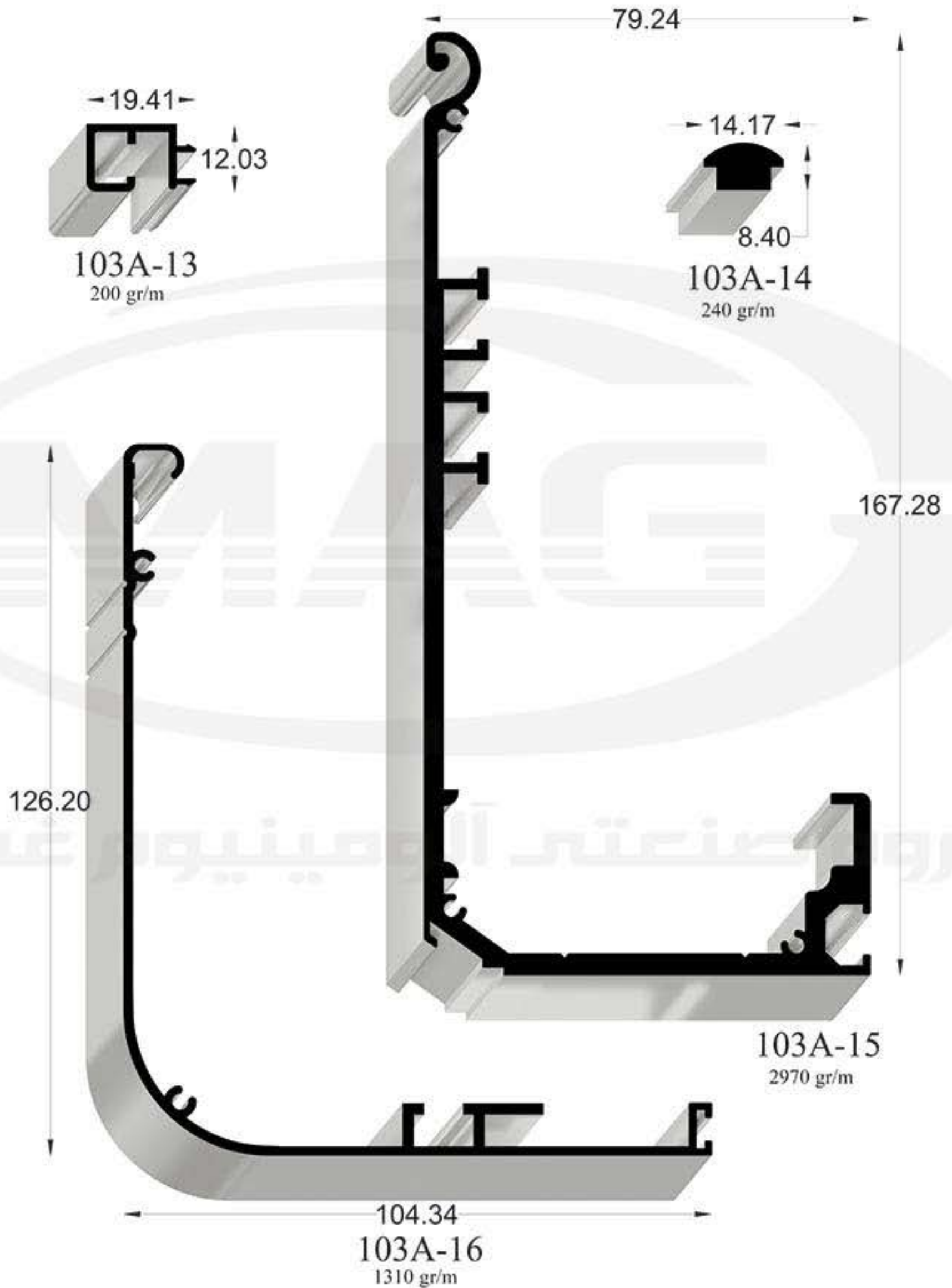

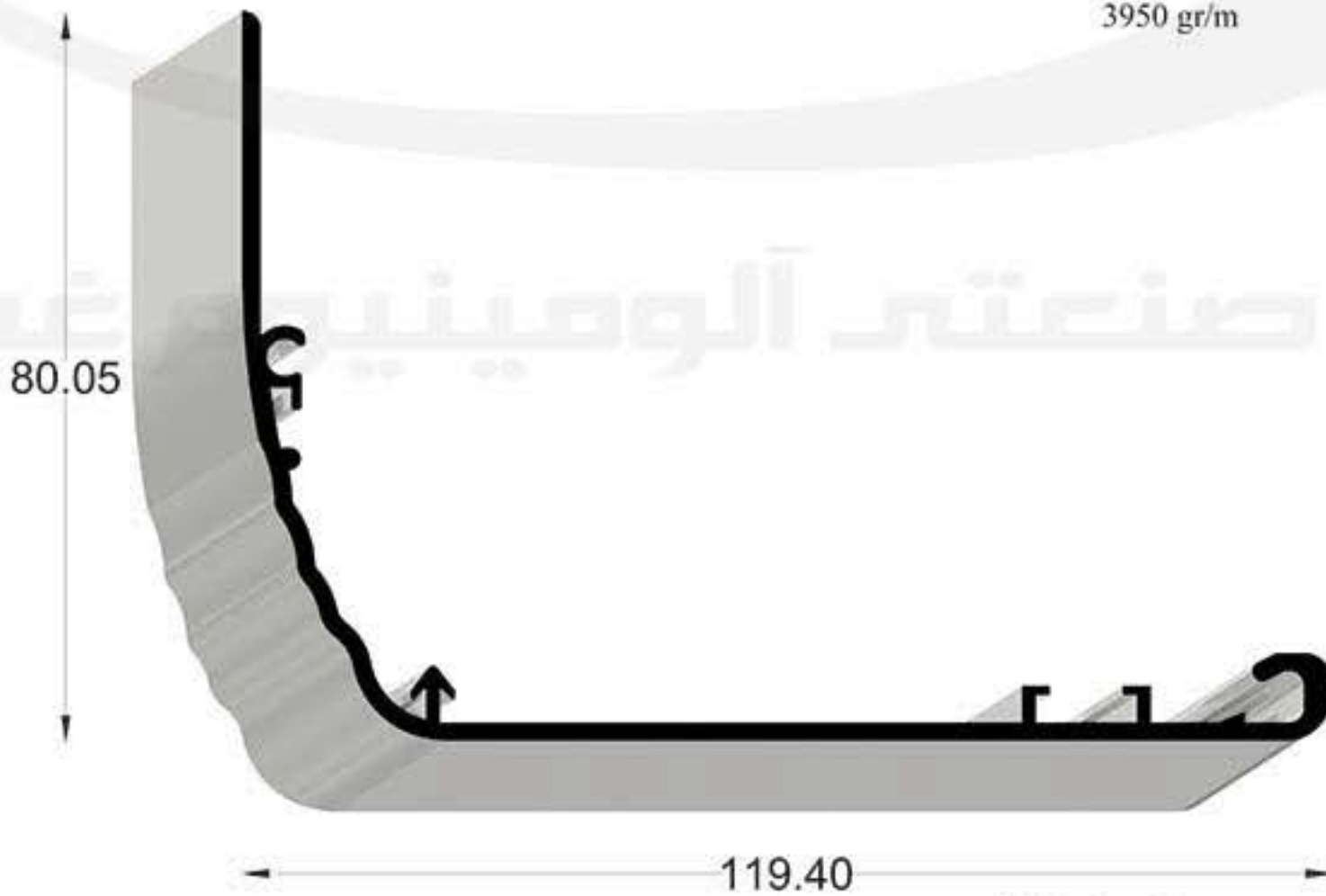
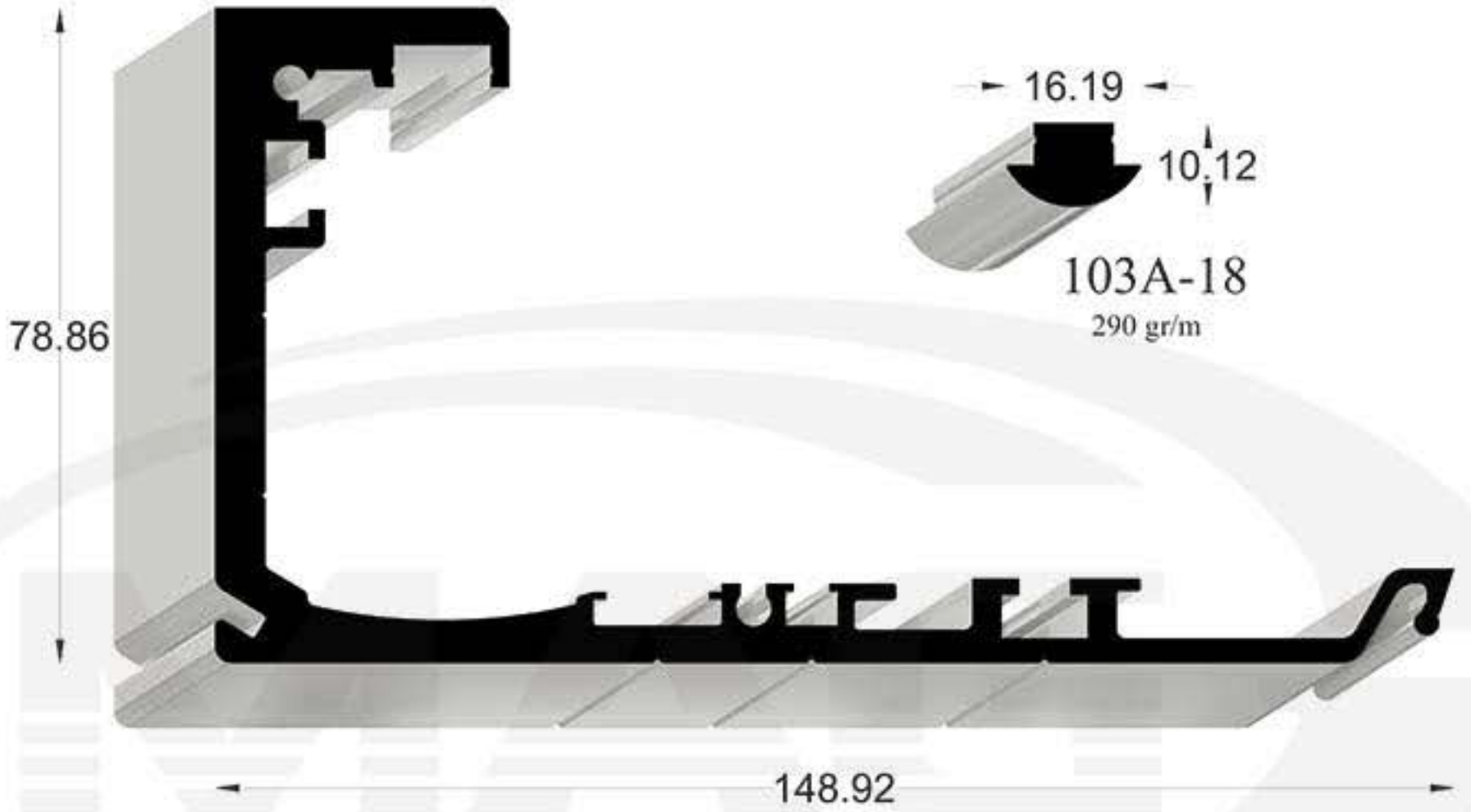

103A-19
1200 gr/m

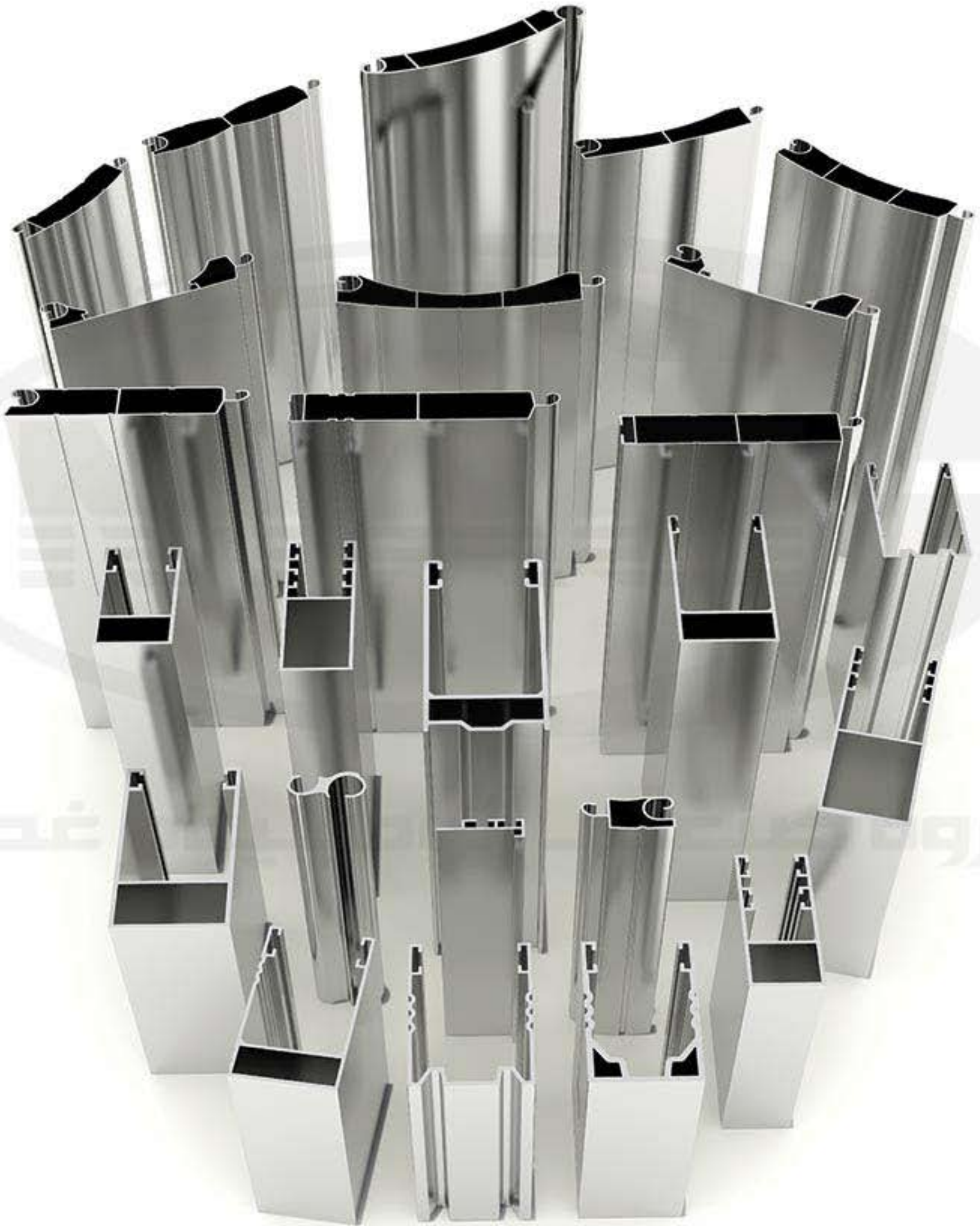

Code:103B

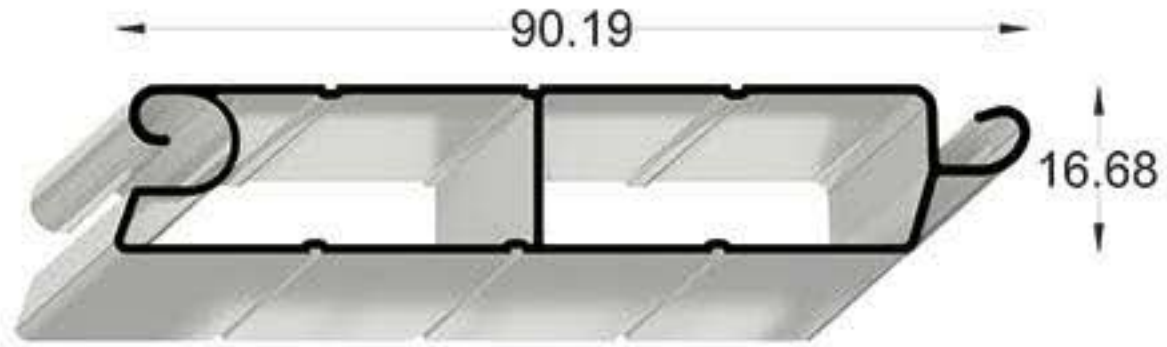

103B-1
600 gr/m



103B-2
290 gr/m



103B-3
580 gr/m

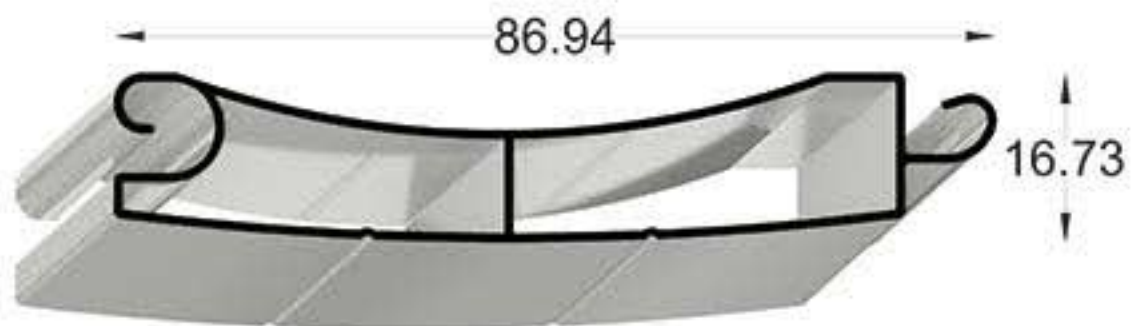

103B-4
540 gr/m

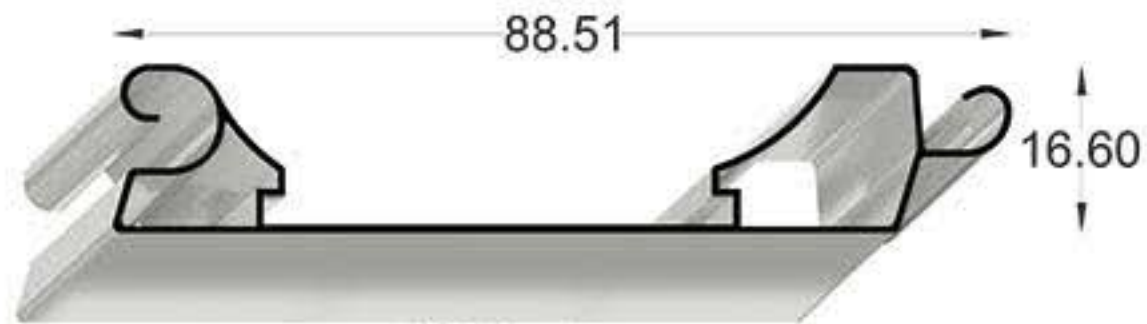

103B-5

136 gr/m

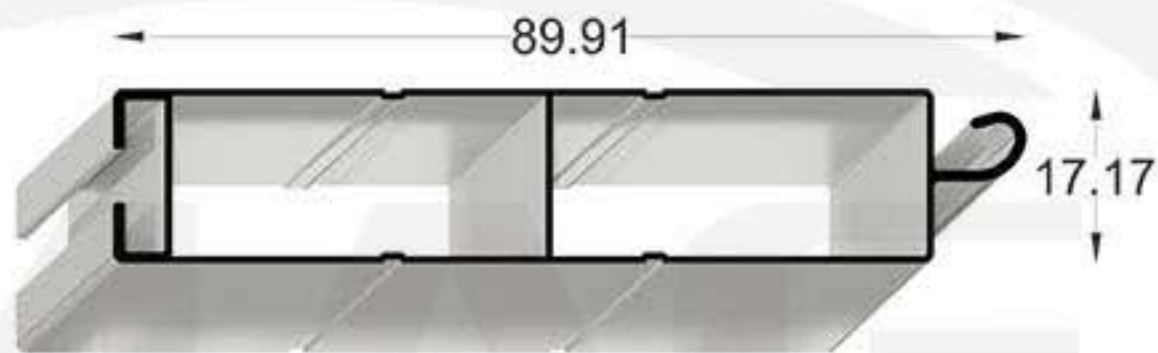

103B-6

480 gr/m

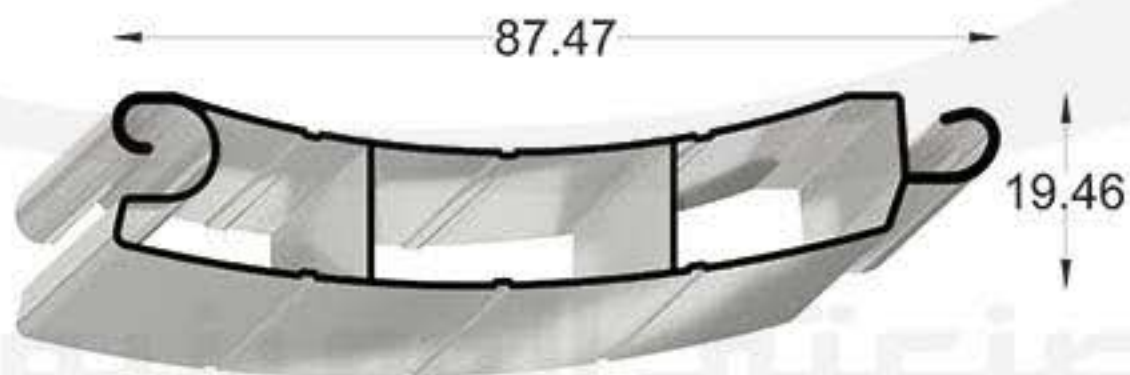

103B-7

520 gr/m

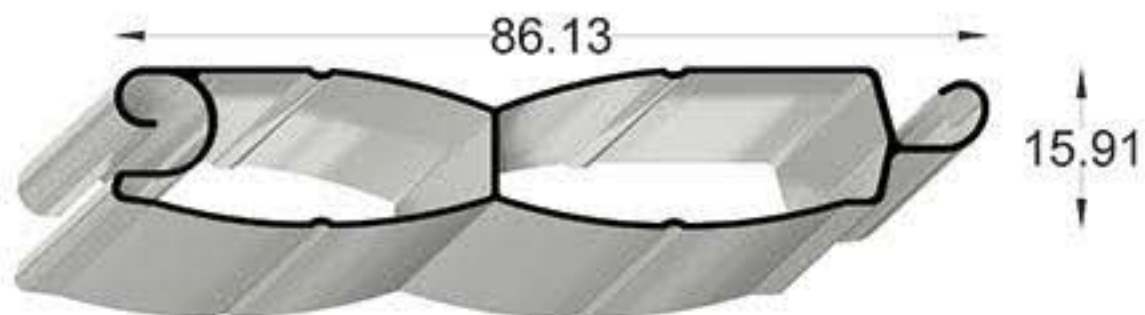

103B-8

411 gr/m

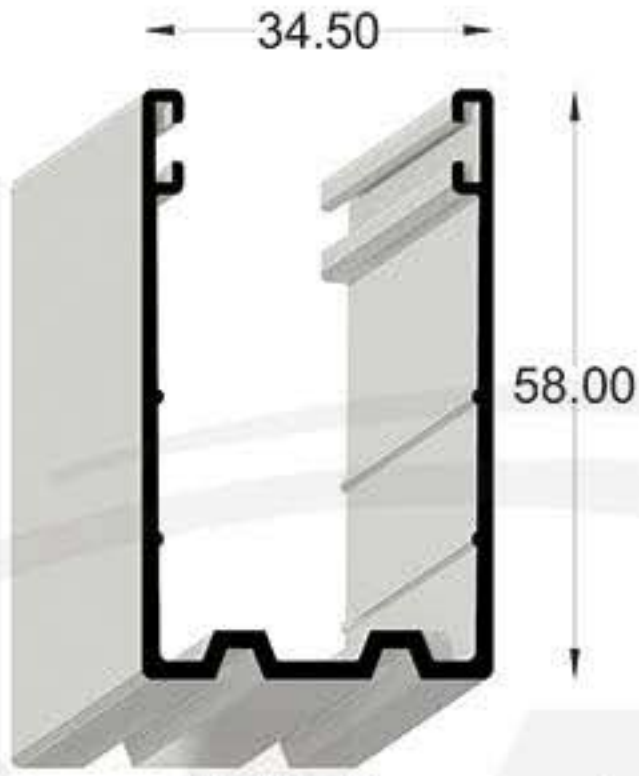

103B-9
720 gr/m

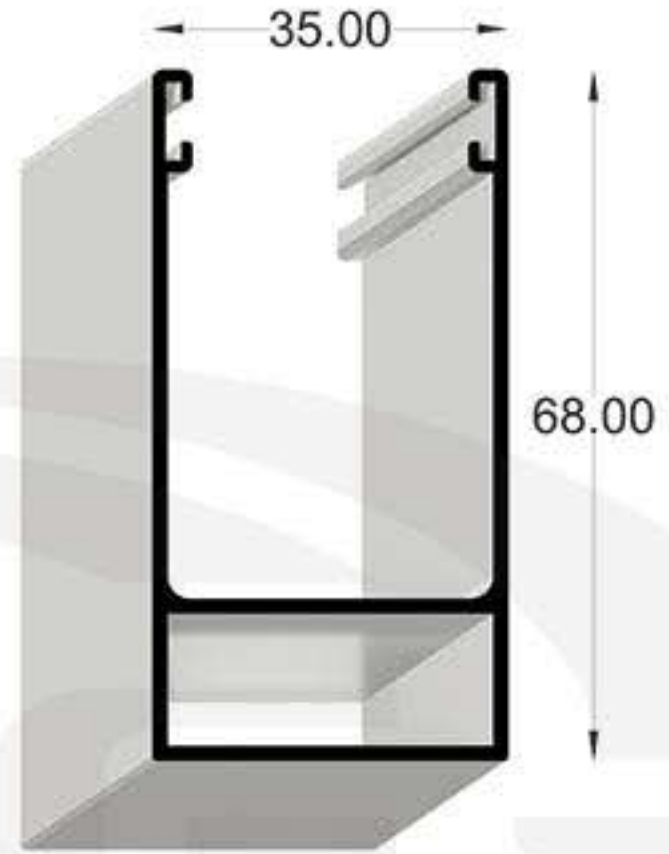

103B-10
850 gr/m

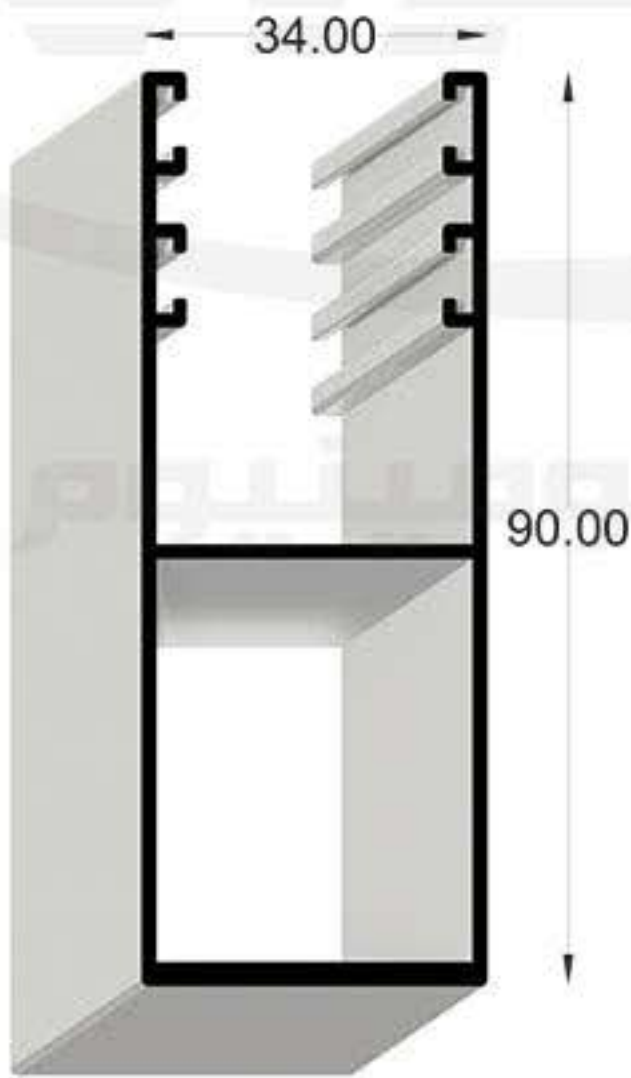

103B-11
1150 gr/m



103B-12
260 gr/m

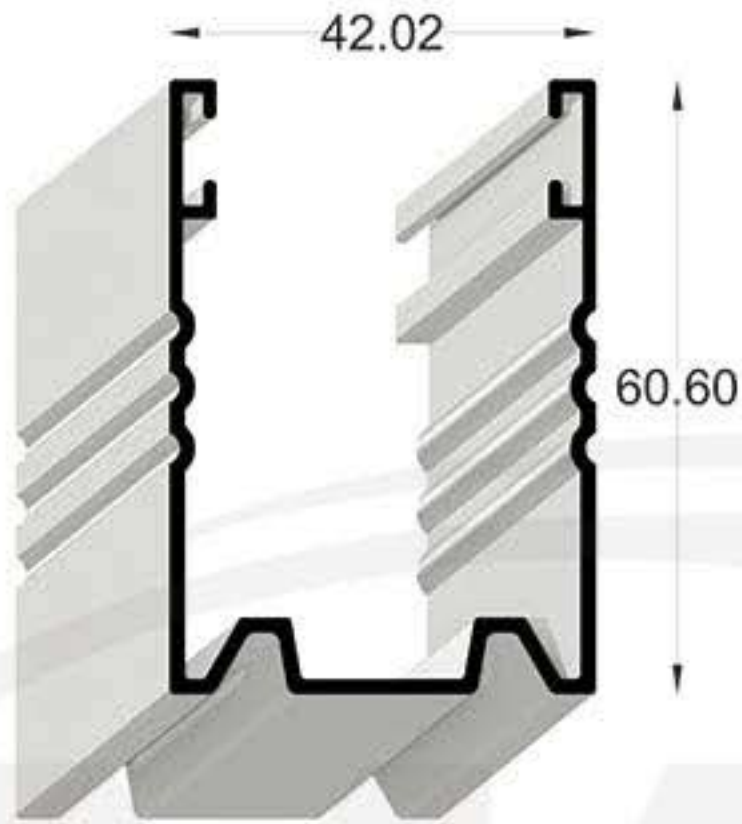

103B-13
790 gr/m

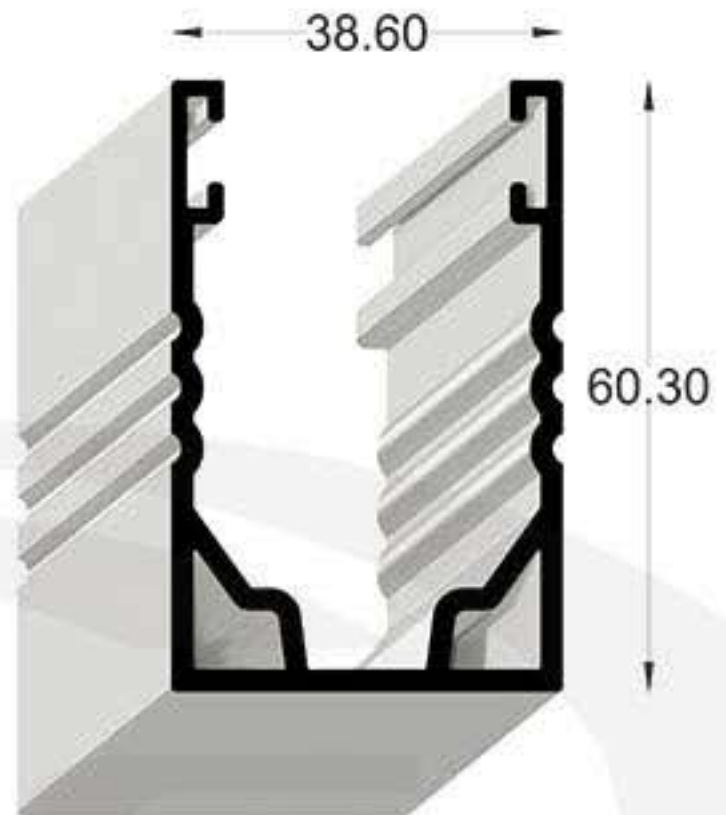

103B-14
1230 gr/m

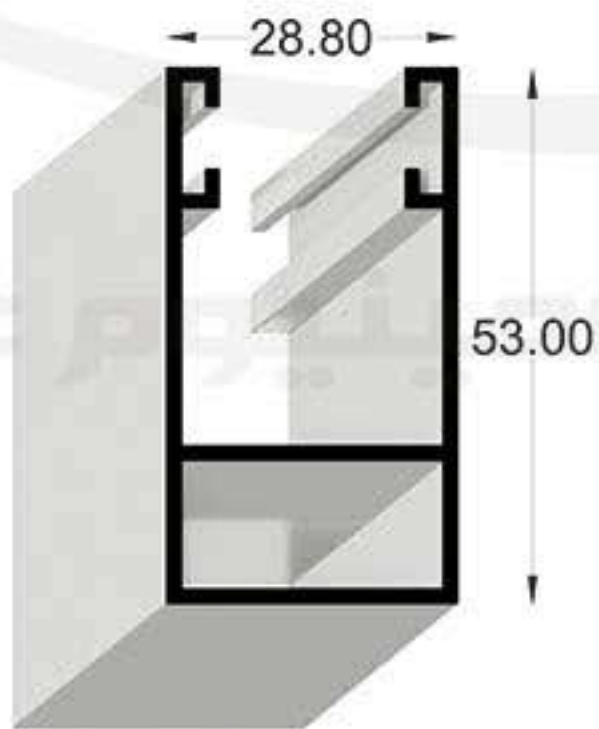

103B-15
780 gr/m

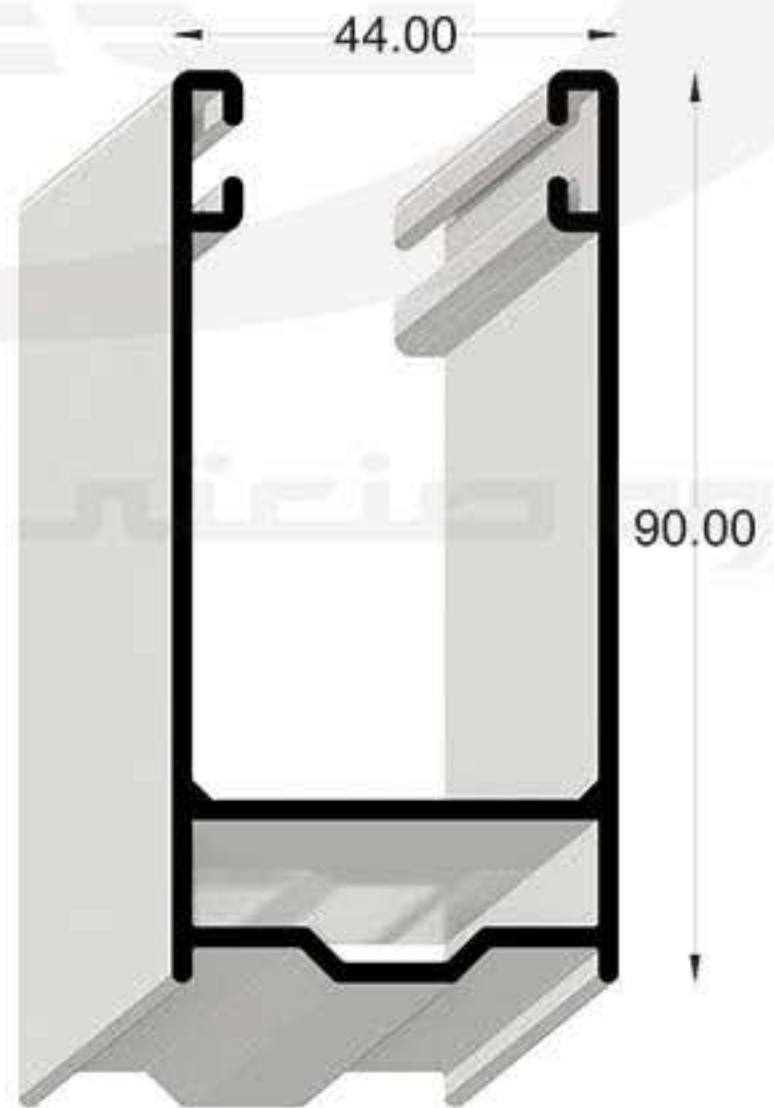

103B-16
1590 gr/m

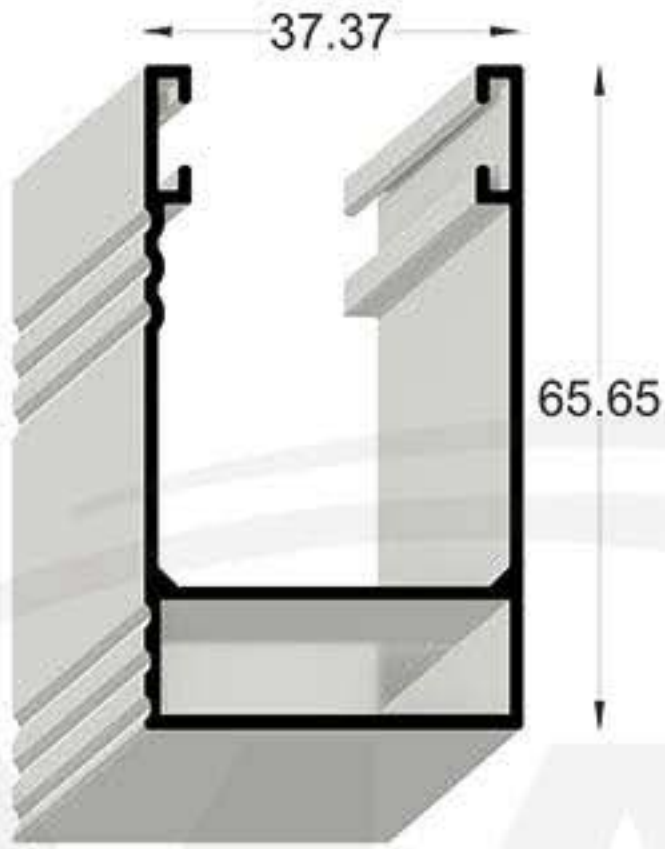

103B-17
820 gr/m

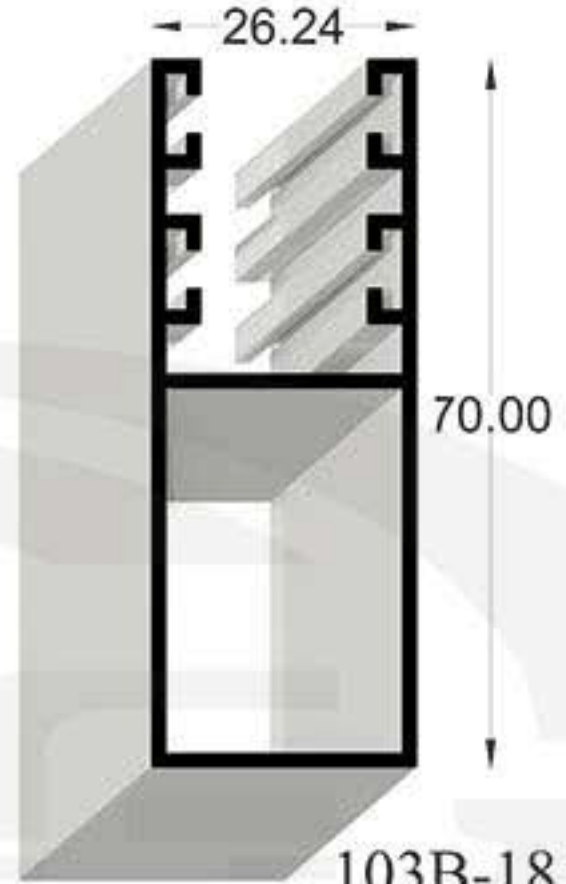

103B-18
920 gr/m

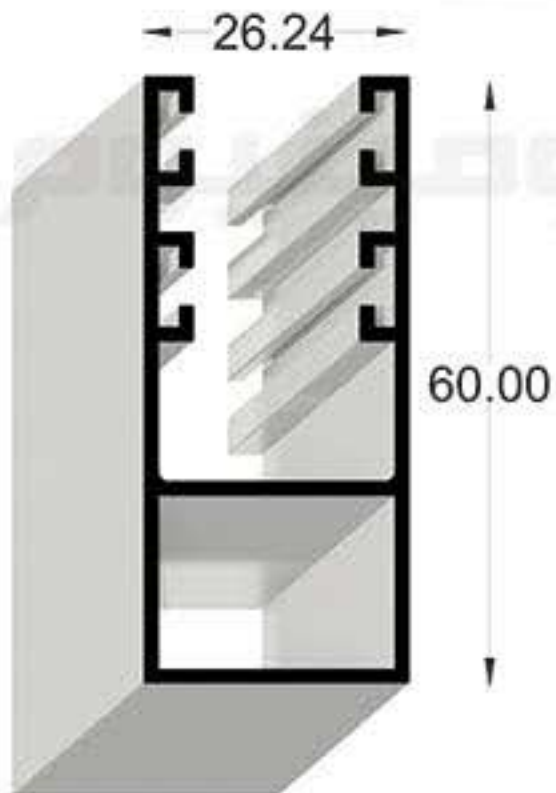

103B-19
840 gr/m

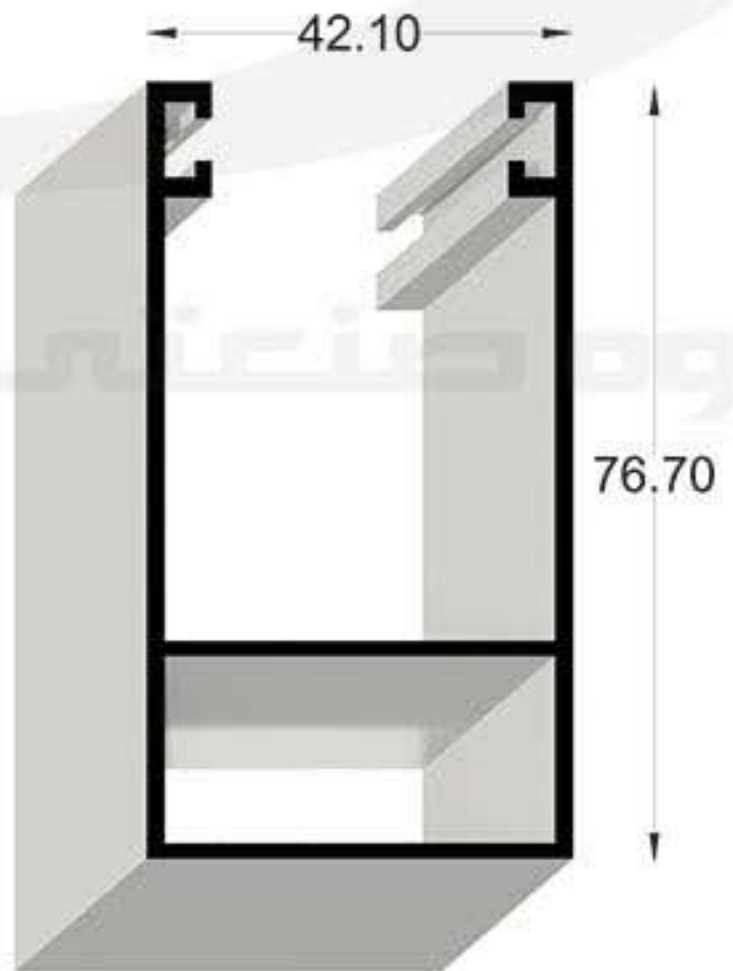

103B-20
1180 gr/m

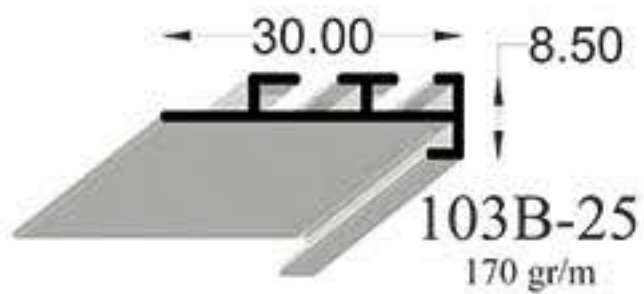
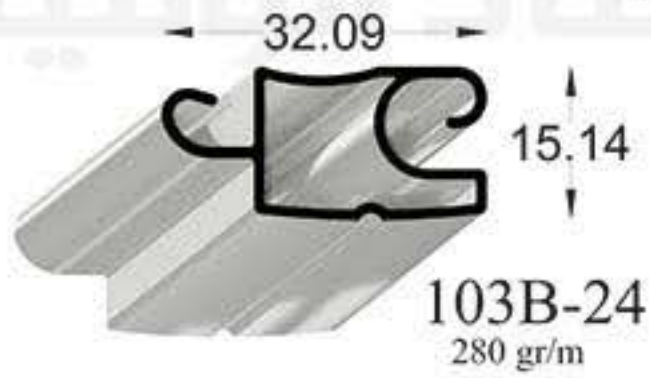
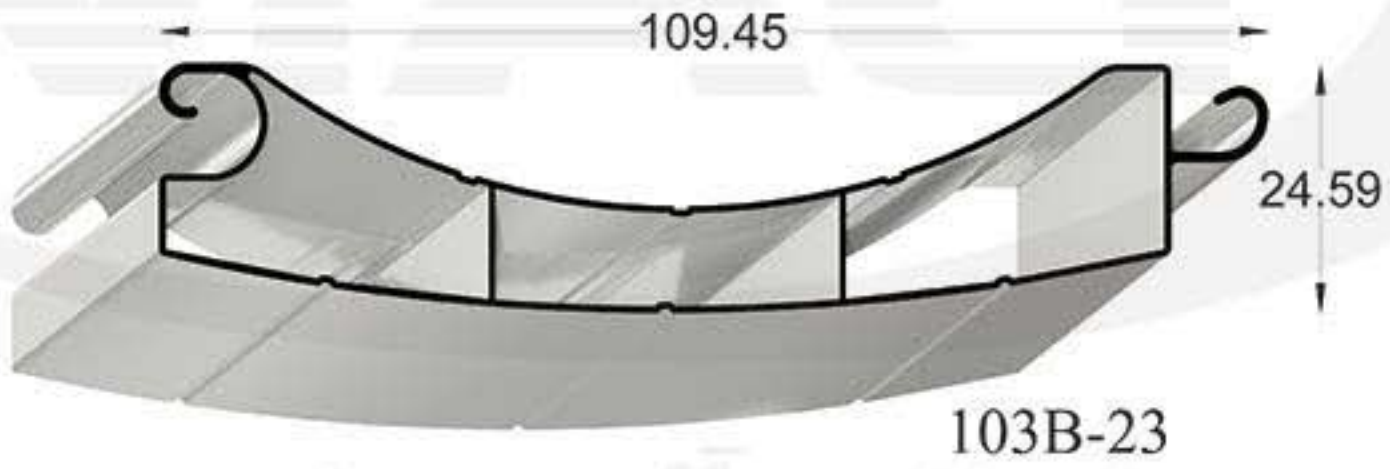
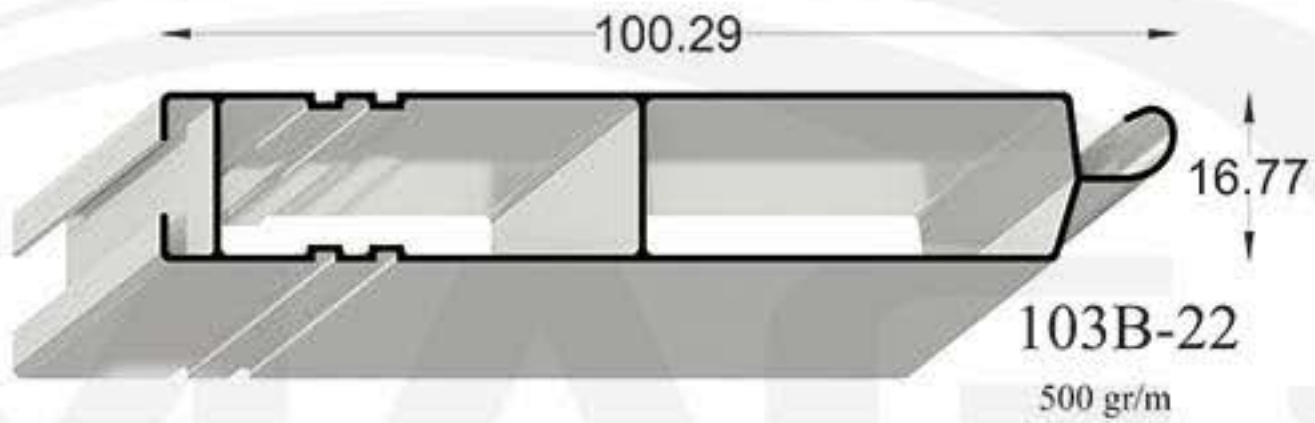



Code 103B

GHADIR ALUMINIUM IND. GROUP





Code:103C



103C-1

240 gr/m



103C-2

220 gr/m



103C-3

210 gr/m

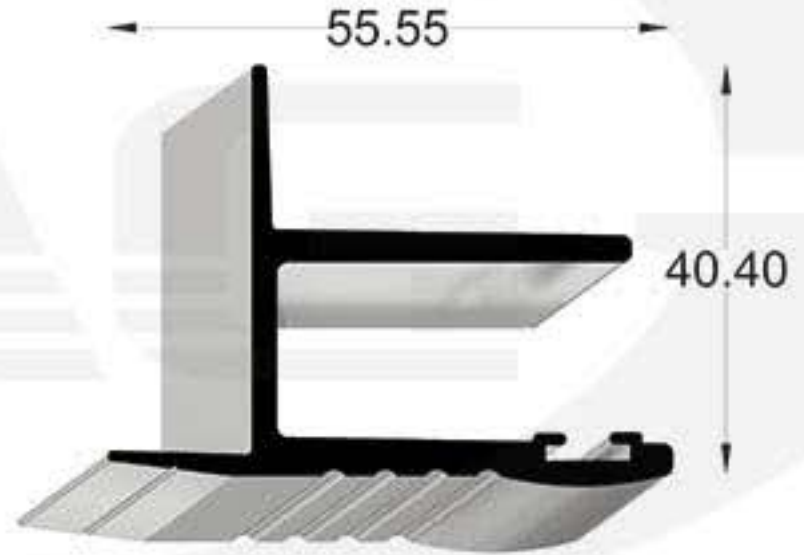

103C-4

950 gr/m

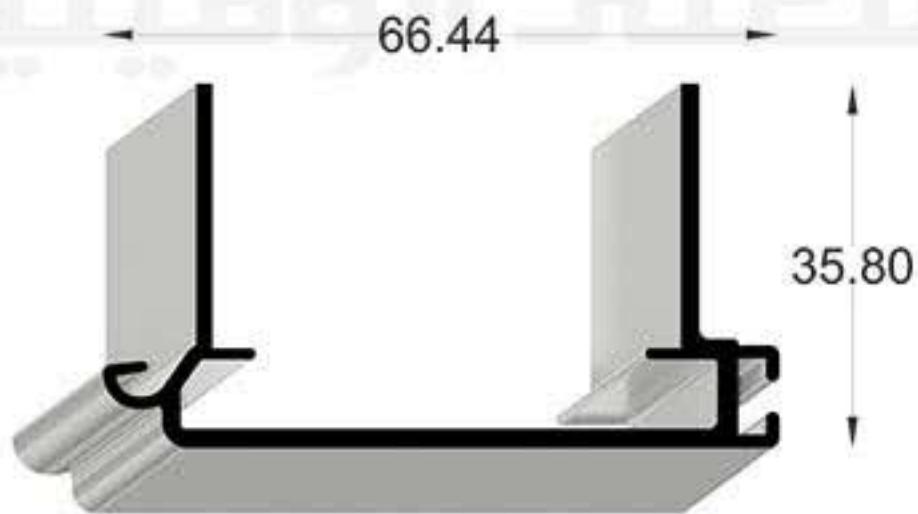

103C-5

720 gr/m