

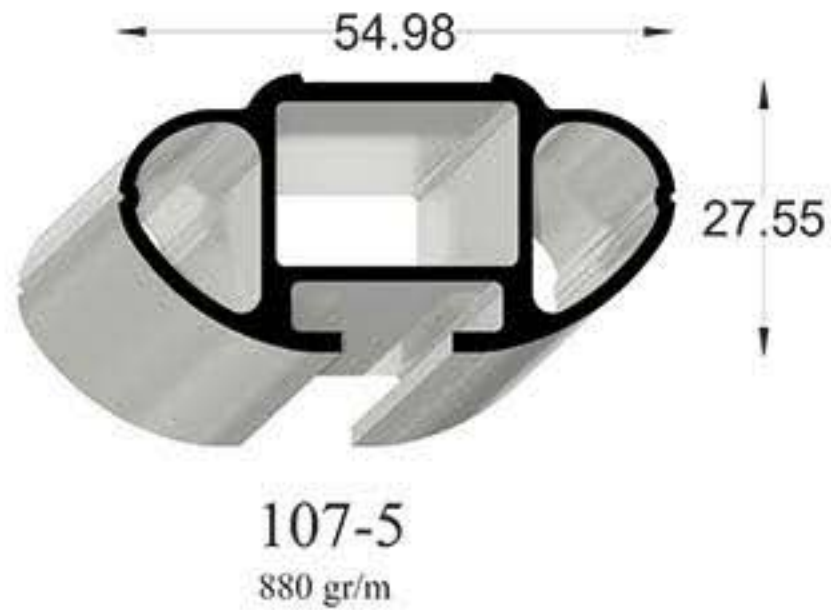

Code:107

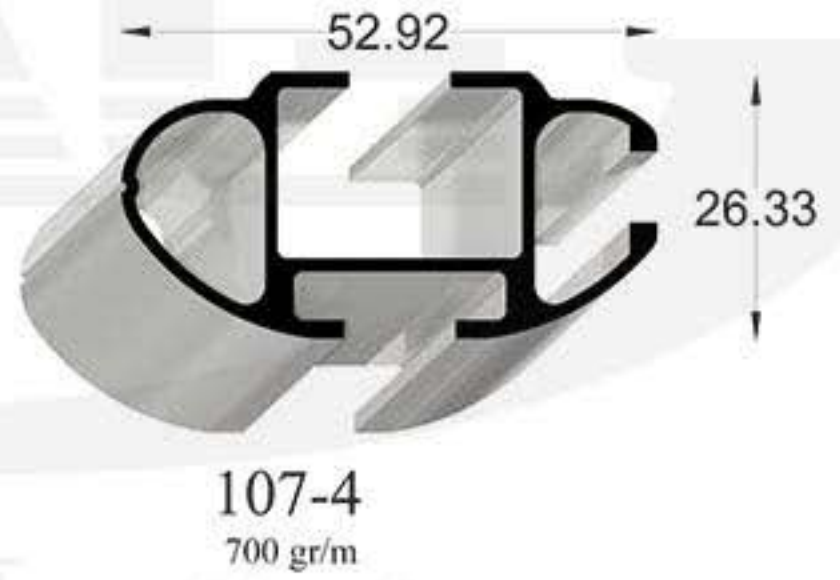

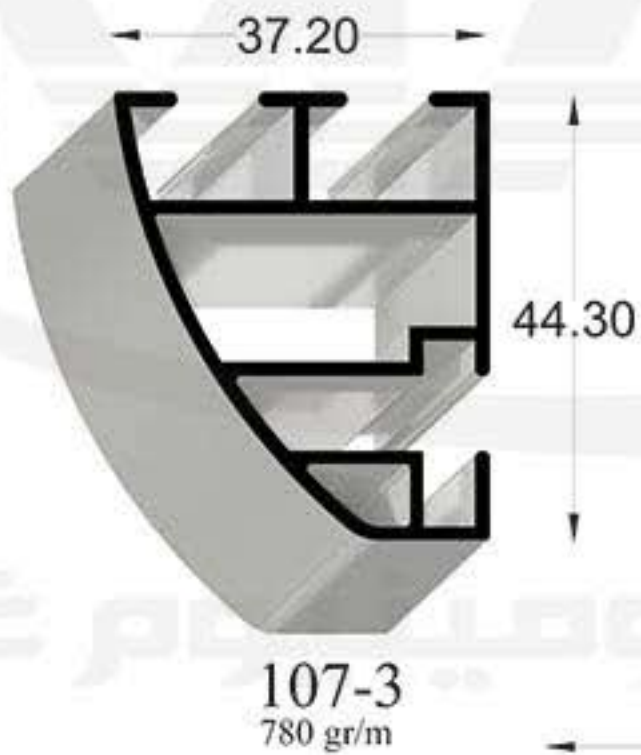
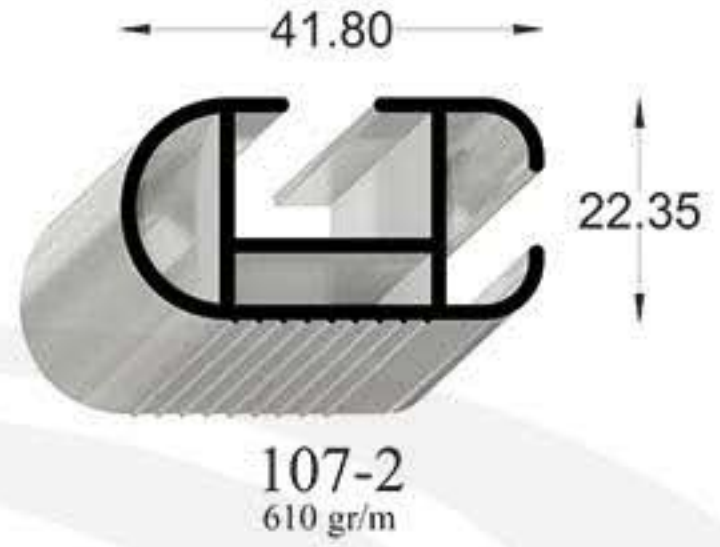
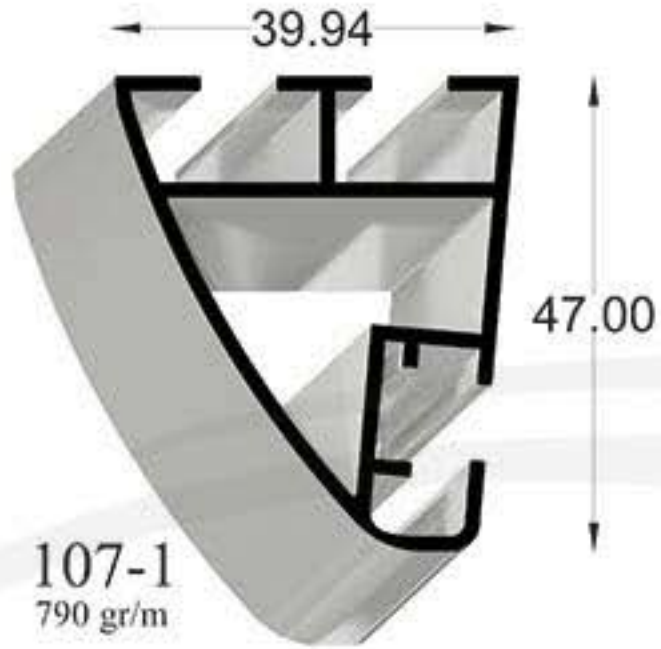
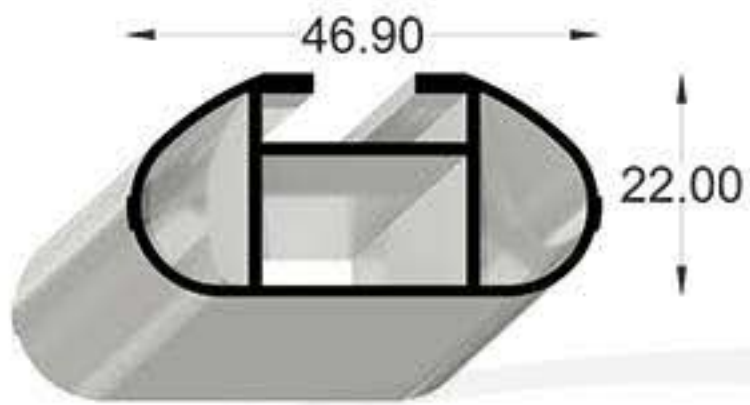

107-6
540 gr/m

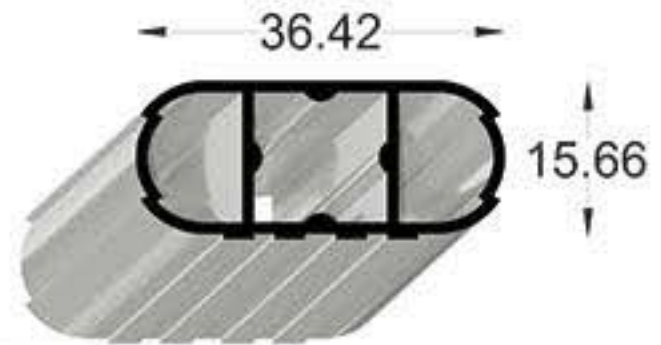

107-7
400 gr/m

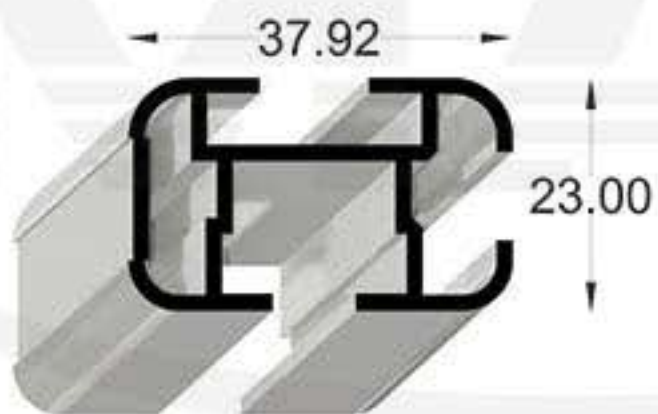

107-8
610 gr/m

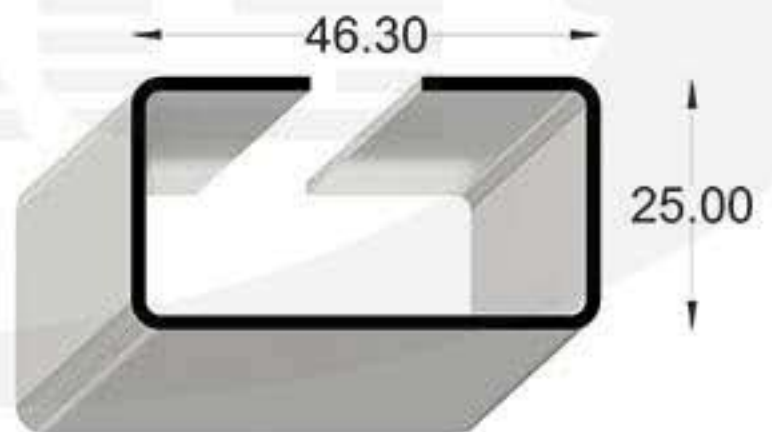

107-9
460 gr/m

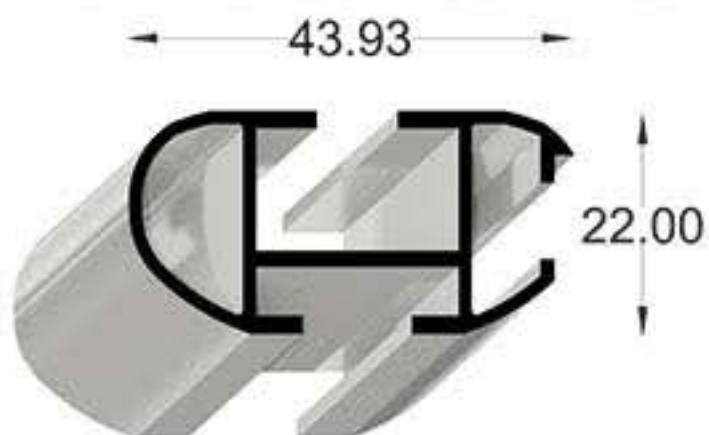

107-10
540 gr/m

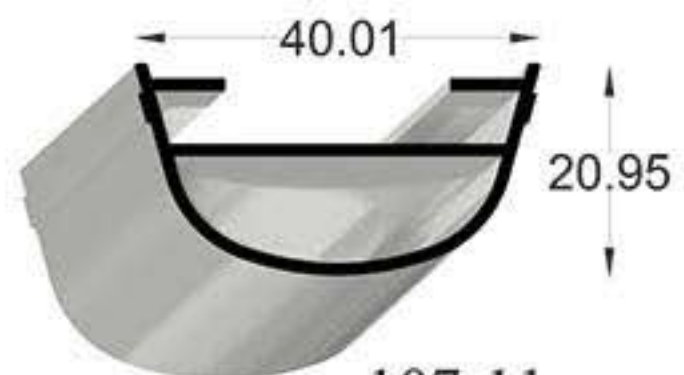

107-11
380 gr/m

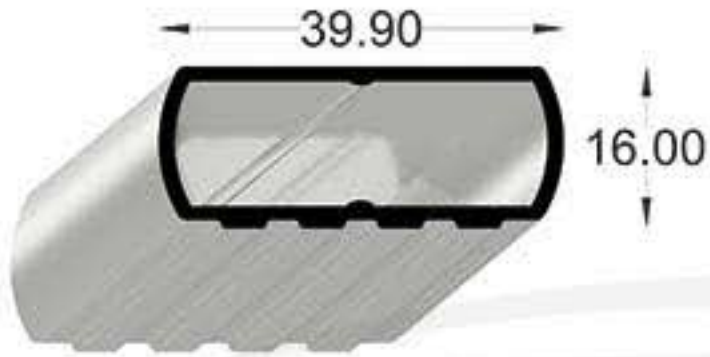

107-12
440 gr/m

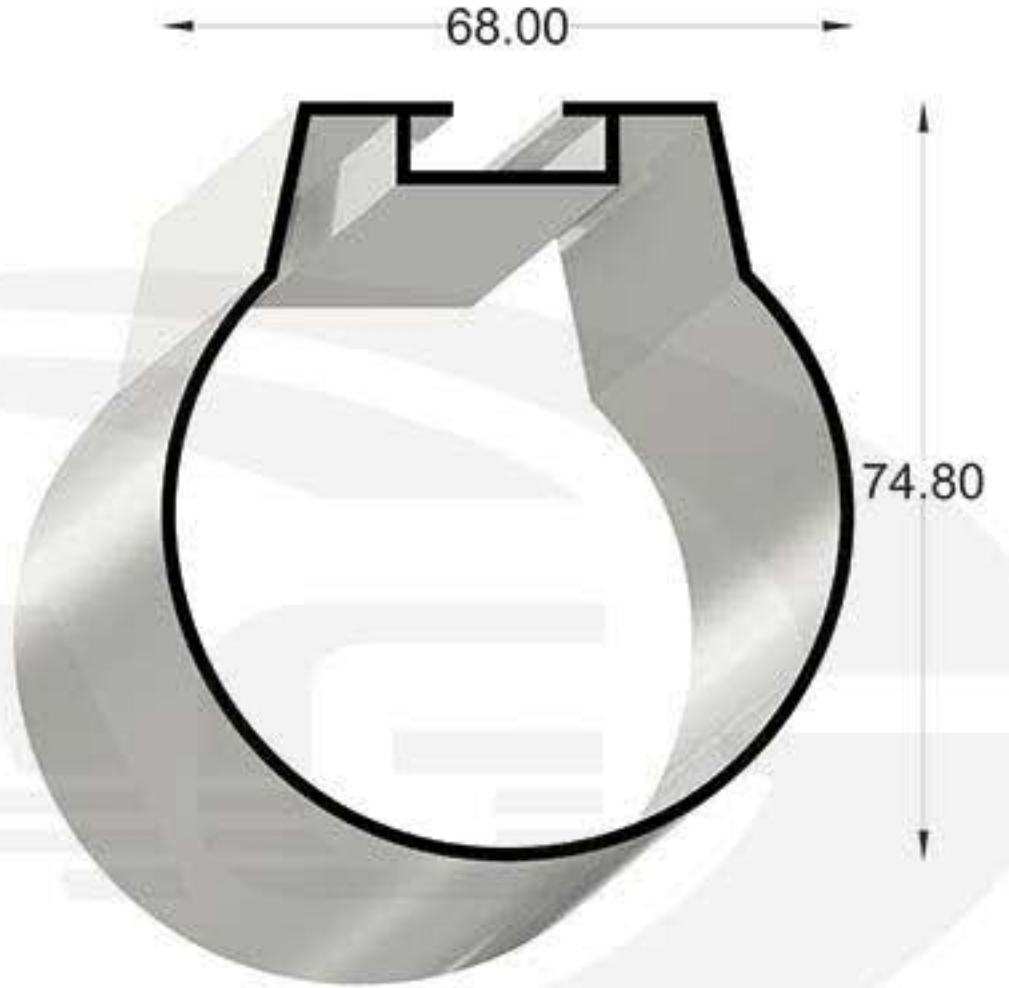

107-14
920 gr/m



107-13
540 gr/m



107-15
380 gr/m

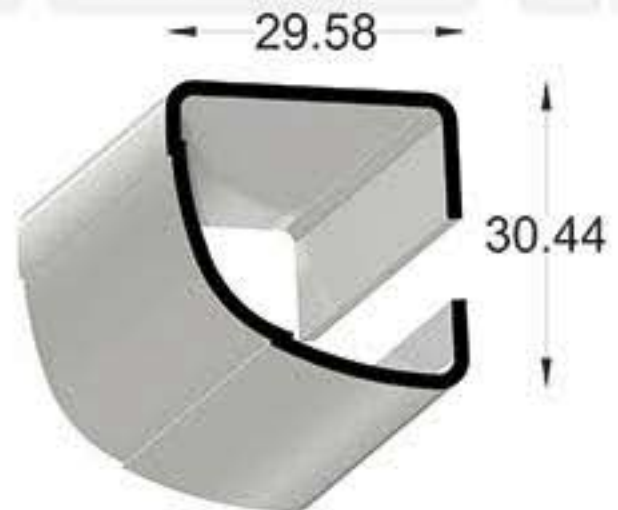

107-16
360 gr/m

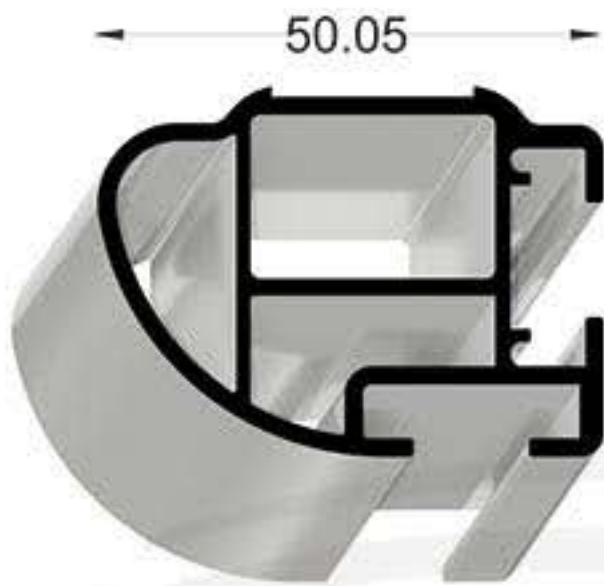

107-17
1100 gr/m

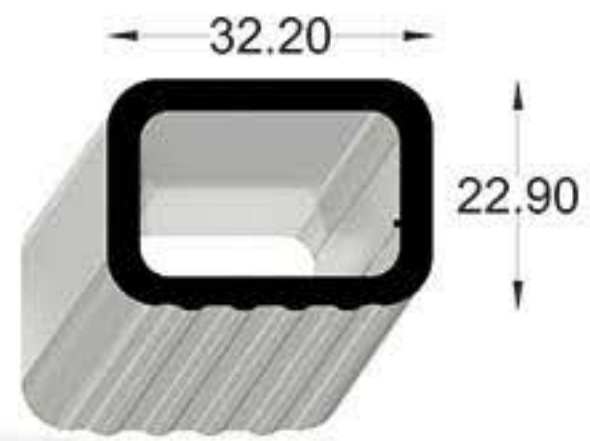

107-18
780 gr/m

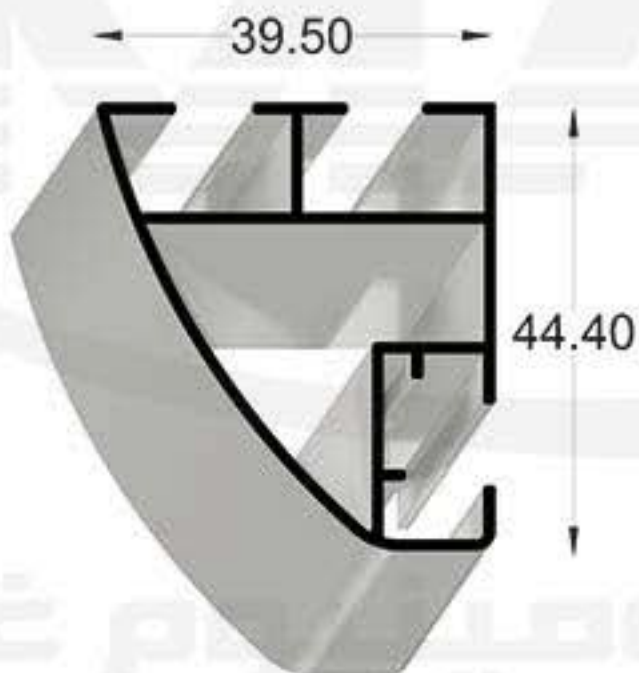

107-19
620 gr/m



107-20
270 gr/m

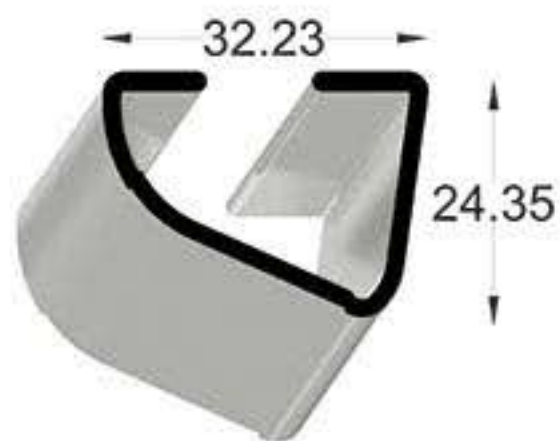

107-21
400 gr/m



Code 107

GHADIR ALUMINIUM IND. GROUP

